



Main catalogue 2018/2019



FA-SA offers a wide product range, suitable for both indoor and outdoor applications, including high-pressure cleaners, vacuum cleaners, wet & dry vacuum cleaners, floor sweepers as well as floor scrubber-driers, carpet cleaners, and steam generators.

NEW

www.fa-sa.it

FA-SA is on line

offering a website rich with information about the company and its products. The site is easy to explore thanks to a navigation system organised around simple and straightforward steps, with continually updated data.

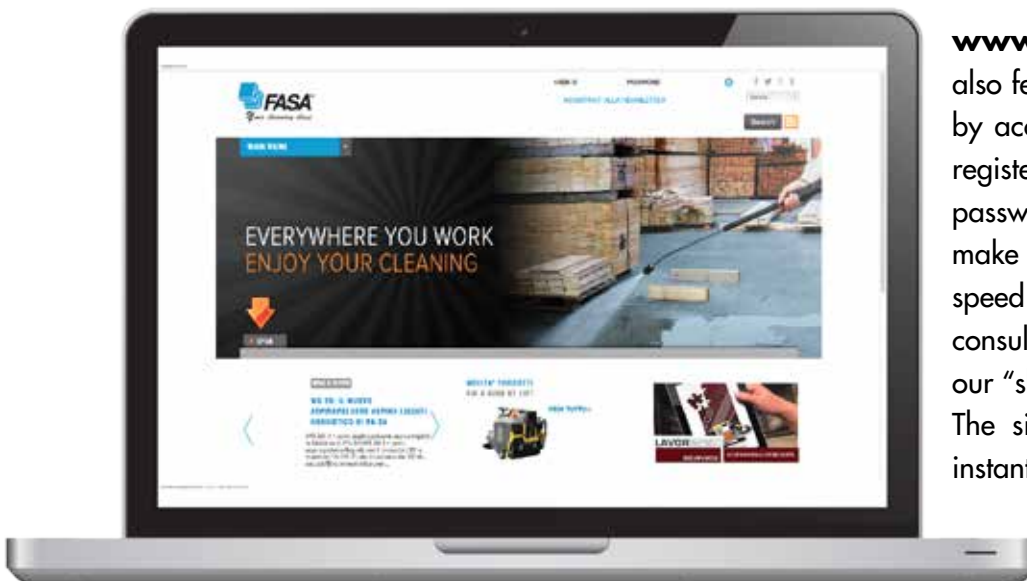

www.fa-sa.it

also features a B2B service enabled by accessing a reserved area after registering your own personal password. Orders are simple to make and send, ensured by the speed with which it is possible to consult our products and thanks to our "shopping basket" feature. The site also includes a series of instant icons to review and check the status of your order as well as see past orders.



HOBBY LINE

Cold and hot water high-pressure cleaners

Compact, handy, ideal for any outdoor cleaning requirement, DIY of high-pressure cleaners is showing its extreme versatility by granting top quality performance, reliability and ease of use. The perfect balance among performance, design and ergonomics makes FA-SA high pressure cleaners an irreplaceable instrument for working, both in DIY and in professional sectors. The complete set of accessories enables applications and usage of the products to be enlarged, by making them functional for any need to wash, hygienise, degrease and disinfest, in a short time and comfortably, any external surface.

Cold water high-pressure cleaners



NEW

Rap 110



Standard equipment:

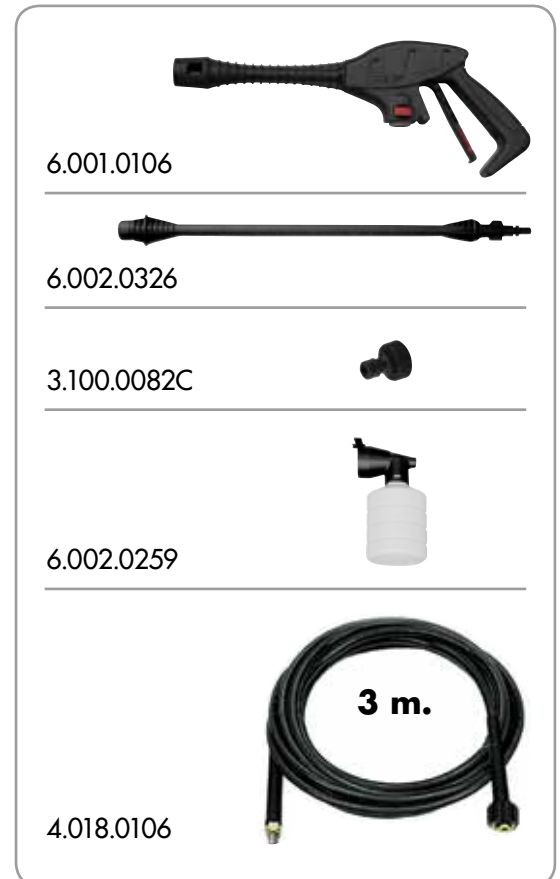

Equipped with:

- Three steel pistons, aluminium axial pump head with built-in by-pass valve.
- Automatic Stop System
- Trolley with ergonomic handle
- Power cable with plug 5 m



Rap 110

Code	8.109.0030C
bar max	110
PSI max	1595
l/h max	330
kW	1.5
Voltage	220-240V~50/60Hz

Cold water high-pressure cleaners

Club 120



Standard equipment:

6.001.0091	
6.002.0361	
6.002.0632	TURBO 
6.002.0636	VARIOJET 
3.100.0082C	
6.002.0259	
4.018.0095	 6 m.
3.601.0115	

Equipped with:

- Three pistons, aluminium pump head with built-in by-pass valve.
- Automatic stop system. • Accessory storage facility. • Trolley with ergonomic handle, granting excellent mobility. • Hose holder. • Power cable with plug 5 m. • Patio cleaner

Club 120

Code	8.092.0058C
bar max	120
PSI max	1740
l/h max	360
kW	1,7
Voltage	220-240V~50/60Hz

Cold water high-pressure cleaners

Indie 140

NEW



Standard equipment:



MULTI WATER JET



Equipped with:

- Three steel pistons, aluminium pump head with built-in by-pass valve
- Trolley with ergonomic handle and accessory holder
- Detergent built-in tank for direct suction
- Cable holder
- Automatic Stop System
- Hose reel
- Power cable with plug 5 m.
- Multi water jet: 3 nozzles (fan jet, turbo, foam)

Indie 140

Code	8.107.0023C
bar max	140
PSI max	2030
l/h max	450
kW	1.9
Voltage	220-240V~50/60Hz

Cold water high-pressure cleaners



Celtic 20

**BRUSHLESS
INDUCTION
MOTOR POWERED**

**AUTOMATIC
STOP**

**TURBO
LANCE**

Standard equipment:

6.001.0091	
6.002.0361	
6.002.0346	TURBO 
6.002.0637	VARIOJET 
3.100.0082C	
6.002.0259	
4.018.0095	 6 m.

Equipped with:

- Low maintenance motor • Three pistons, aluminum pump head with built-in by-pass valve • Automatic Stop System • Hose-holder
- Ergonomic handle • Accessory storage facility • Power cable 5 m.



Celtic 20

Code	8.108.0004C
bar max	140
PSI max	2030
l/h max	360
kW	2,0
Voltage	220-240V~50/60Hz

Cold water high-pressure cleaners

Fusion 20

**BRUSHLESS
INDUCTION
MOTOR POWERED**



Standard equipment:



Equipped with:

- Low maintenance motor
- Three steel pistons, aluminium pump head with built-in by-pass valve.
- Side holder to site lance and gun matched together (ready for use).
- Built-in detergent tank for direct suction.
- Accessory storage facility.
- Automatic stop system.
- Trolley with ergonomic handle granting excellent mobility.
- Power cable 5 m.



Fusion 20

Code	8.105.0007
bar max	140
PSI max	2030
l/h max	400
kW	2,1
Voltage	220-240V~50/60Hz

Cold water high-pressure cleaners



NEW

Fusion 24

**BRUSHLESS
INDUCTION
MOTOR POWERED**



Standard equipment:



Equipped with:

- Low maintenance motor • Three steel pistons, aluminium pump head with built-in by-pass valve • Trolley with ergonomic handle and accessory holder • Detergent built-in tank for direct suction • Hose reel • Cable holder • Side holder to site lance and gun matched together (ready for use) • Automatic Stop System • Power cable with plug 5 m.

Fusion 24

Code	8.105.0010
bar max	145
PSI max	2103
l/h max	480
kW	2.4
Voltage	230V~50Hz



Cold water high-pressure cleaners

Rumba 150

NEW



Equipped with:

- Three pistons, aluminium pump head with built-in by-pass valve.
- Automatic stop system.
- Side holder to site lance and gun matched together (ready for use).
- Trolley with ergonomic handle granting excellent mobility.
- Power cable with plug 5 m.
- Multi water jet: 3 nozzles (fan jet, turbo, foam)

Standard equipment:



MULTI WATER JET



	Rumba 150
Code	8.086.0168C
bar max	150
PSI max	2175
l/h max	450
kW	2,1
Voltage	220-240V~50/60Hz

Cold water high-pressure cleaners

Techno 160 S

NEW



Standard equipment:



Equipped with:

- Three pistons, aluminium pump head with built-in by-pass valve.
- Detergent built-in tank for direct suction • Automatic Stop System
- Ergonomic handle with accessory holder • Cable holder • Hose reel
- Power cable with plug 5 m. • Multi water jet: 3 nozzles (fan jet, turbo, foam)

Techno 160 S

Code	8.086.0159C
bar max	160
PSI max	2320
l/h max	510
kW	2.5
Voltage	220-240V~50/60Hz



MULTI WATER JET

Cold water high-pressure cleaners

Progressive 28



**BRUSHLESS
INDUCTION
MOTOR POWERED**



Standard equipment:



Equipped with:

- Three steel pistons, **brass pump** head with built-in by-pass valve
- Full assembled (ready for use)
- Trolley with ergonomic handle and accessory holder
- Detergent built-in tank for direct suction
- Hose reel
- Cable holder
- Side holder to site lance and gun matched together (ready for use)
- Automatic Stop System

Progressive 28

Code	8.078.0008
bar max	160
PSI max	2320
l/h max	510
kW	2,8
Voltage	230V~50Hz



Hot water high-pressure cleaners

King



Standard equipment:



6.001.0078



6.002.0183



3.100.0082



6.002.0162

PROFESSIONAL



4.018.0003

8 m.

Equipped with:

- Burner regulation, optimized combustion
- Three high durability steel pistons, aluminium axial pump head with built-in bypass valve
- Vertical burner with high thermal efficiency steel coil
- Safety valve
- Automatic temperature regulation
- Ergonomic handle complete with accessory holder.
- Automatic Stop System
- Power cable with plug

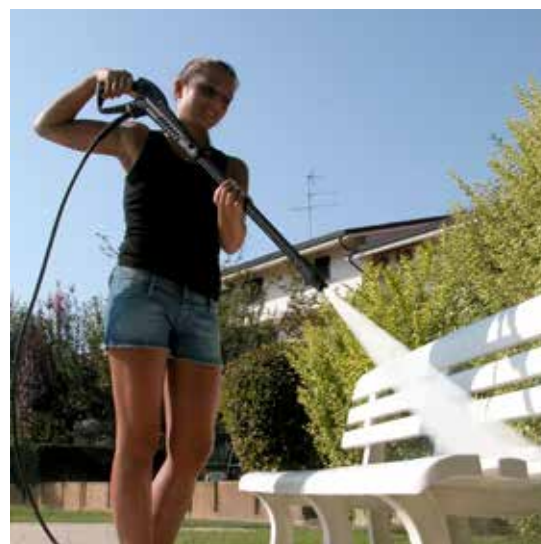

	King
code	8.054.0009
bar max	145
PSI max	2103
l/h max	450
kW	2,3
RPM	2800
Temp. max	80° C
Voltage	230V~50Hz

Hot water high-pressure cleaners

Kappa A



**INDUCTION
MOTOR POWERED**



Standard equipment:



3.700.0036



6.002.0260



PROFESSIONAL

8 m.

4.618.0049

Equipped with:

- Burner regulation, optimized combustion • Double motor (pump and burner)
- Three high durability steel pistons, aluminium axial pump head with built-in bypass valve • Vertical burner with high thermal efficiency steel coil • Safety valve • Automatic temperature regulation • Ergonomic handle complete with detergent tank and accessory holder (lance, gun, h.p. hose, cable)
- Automatic Stop System • Direct detergent suction with built-in tank • Power cable with plug



	King
code	8.052.0803
bar max	145
PSI max	2103
l/h max	450
kW	2,3
RPM	2800
Temp. max	90° C
Voltage	230V~50Hz

Hot water high-pressure cleaners

Kaiman



Equipped with:









































- Three high durability steel pistons, brass axial pump head with built-in by-pass valve
- Double motor (pump and burner)
- Vertical burner with high thermal efficiency steel coil.
- Temperature regulation gauge. • Glycerine pressure gauge
- Automatic Stop System • Detergent built-in tank for direct suction.
- Power cable with plug

Standard equipment:















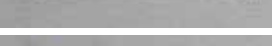







	Kaiman
code	8.619.0608
bar max	150
PSI max	2175
l/h max	570
kW	3
RPM	2800
Temp. max	90° C
Voltage	230V~50Hz











Accessories for cold water high-pressure cleaners

	6.010.0044	Gun with quick connection	
	6.010.0096	Gun with quick connection	
	6.010.0043	Detergent diffuser + tank, quick connection	
	6.010.0046	S99 fixed lance Ø 1,15	 
	6.010.0047	S99 lance with adjustable fan jet plus high/low pressure Ø 1,15	 
	6.010.0048	SY'99 lance with adjustable fan jet plus high/low pressure Ø 1,15	  
	6.010.0050	S99 turbo lance Ø 1,10	
	6.010.0049	Brass turbo lance Ø 1,2	
	6.010.0053	High pressure hose 6 m extension	 
	6.010.0039	6 m pipe-cleaning hose	 
	6.010.0095	10 m pipe-cleaning hose (10 m pipe-cleaning hose M22 coupling)	
	6.010.0052	15 m pipe-cleaning hose	
	6.010.0110	6 m domestic pipe-cleaning hose	
	6.010.0111	10 m domestic pipe-cleaning hose	
	6.010.0112	15 m domestic pipe-cleaning hose	
	6.010.0040	Sand blasting lance	
	6.010.0038	Fixed brush	
	6.010.0037	Rotary brush	
	6.008.0151	Patio cleaner SKATER	
	6.010.0041	3 universal adapters set	
	6.010.0100	Water filter 3/4 F	
	6.010.0097	Antifreeze set	

Accessories for cold water high-pressure cleaners

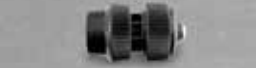
	code	description	Zumba	Club	Mambo	Celific	Fusion	Fox	Rumba	Techno 160 S	Progressive
	6.001.0091	S'09 gun with quick connection		S		S	O		S	S	
	6.001.0083	S'09 gun with quick connection, 1/4" M connection adapter	O	O	O	O	O		O	O	
	6.005.0322	S'09 gun kit with hose 6 m	O	O	O	O	O		O	O	
	6.001.0078	S'10 gun with quick connection						S			S
	6.001.0106	S'16 gun with quick connection	S								
	6.001.0084	S'09 gun with quick connection			S		S				
	4.018.0094	High pressure hose 4 m, quick connection	O	O	O		O				
	4.018.0095	High pressure hose 6 m, quick connection		S	O	S	O		S		
	4.018.0096	High pressure hose 8 m, quick connection		O	S	O	S		O	S	
	4.018.0067	High pressure hose 8 m, quick connection (professional hose)		O	O	O	O		O	O	S
	4.018.0073	High pressure hose 8 m, 1/4" F connection						SA			
	4.018.0106	High pressure hose 3 m, quick connection	S								
	6.002.0360	S'02V fixed lance Ø 0,85	S								
	6.002.0215C	S'99 lance with adjustable fan jet plus high/low pressur Ø 1,00				O	S		O	O	
	6.002.0186	SY'99 lance with adjustable fan jet plus high/low pressur Ø 1,20						O			O
	6.002.0185	SY'99 lance with adjustable fan jet plus high/low pressur Ø 1,15						S			
	6.002.0329	Turbo lance S'01 Ø 1,025	S	S							
	6.002.0223	Brass turbo lance Ø 1,20						S			S
	6.002.0325	Lance with quick connection nozzle						O			S
	5.012.0298	4 nozzle set						O			
	5.012.0478	5 nozzle set									S
	6.002.0203	Curved lance	O	O	O	O	O	O	O	O	O
	6.002.0361	Lance for nozzle head		S	S	S	S		S	S	
	6.002.0343	High pressure nozzle head Ø 1,0		O	O	O	O		O	O	
	6.002.0634	Foam jet nozzle head			S		O				
	6.002.0346	Turbo with ceramic nozzle head Ø 1,025			S	S	S				S
	6.002.0632	Turbo nozzle head Ø 1,025		S					S		
	6.002.0635	High pressure variojet nozzle head Ø 0,9			S				S		
	6.002.0636	High pressure variojet nozzle head Ø 0,95		S						S	
	6.002.0637	High pressure variojet nozzle head Ø 1,00				S					
	6.002.0177	Sand blasting lance	O	O	O	O	O	O	O	O	O

Accessories for cold water high-pressure cleaners

			Zumba	Club	Mambo	Celtic	Fusion	Fox	Rumba	Techno 160 S	Progressive
	6.003.0037	6 m pipe-cleaning hose	○	○	○	○	○	○	○	○	○
	6.003.0048	10 m pipe-cleaning hose	○	○	○	○	○	○	○	○	○
	6.003.0052	15 m pipe-cleaning hose	○	○	○	○	○	○	○	○	○
	3.601.0033	Fixed brush	○	○	○	○	○	○	S	○	○
	3.601.0074	Rotary brush	○	○	S	○	○	○	○	○	○
	3.601.0035	Rotary brush	○	○	○	○	○	○	○	S	○
	5.012.0319	Suction kit			○	○	○	○	○	○	○
	6.002.0259	Foam sprayer	S	S	○	S	○	○	S	S	○
	4.006.0062	Quick hose coupling 1/4" M x M22	○	○	○	○	○	○	○	○	○
	3.100.0082	Quick hose coupling	○	○	S	○	S	S	○	○	S
	3.100.0082C	Quick hose coupling	S	S	○	S	○	○	S	S	○
	3.100.0062	Quick hose coupling	○	○	○	○	○	○	○	○	○
	5.009.0486	3m plastic water inlet	○	○	○	○	○	○	○	○	○
	3.102.0011	Suction filter 3/4F - 3/4 M	○	○	○	○	○	○	○	○	○
	6.002.0332	Turbo lance Ø 1,25									○
	3.100.0405	Water filter 3/4 F	○	○	○	○	S	○	○	○	○

S = standard equipment

○ = optional

Accessories for cold water high-pressure cleaners

Curved lances

6.010.0104 • High pressure curved lance - jet angle 30°



6.002.0203 • Metal high-pressure curved lance - jet angle 135°

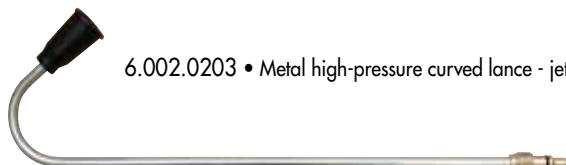

5.012.0445 • High-pressure metal curved lance with 4 interchangeable nozzles, jet angle 135°



Multi Water Jet lance



Multi Water Jet lance Code: 6.002.0366 + 6.002.0369



Domestic pipe cleaning hose with nozzle

6.010.0110 **Mt. 6 - max 130 bar** pipe cleaning hose

6.010.0111 **Mt. 10 - max 130 bar** pipe cleaning hose

















6.010.0112 **Mt. 15 - max 130 bar** pipe cleaning hose



Micro pipe cleaning hose to be connected to the high pressure cleaner to clean all household draining pipes. The three high pressure jets ensure the autonomous advancing of the pipe cleaning hose, disrupting any obstruction.

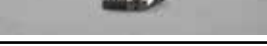

Accessories for hot water high-pressure cleaners

			King	Kappa A	Kaiman
	3.700.0036	Gun 21 MPA		S	S
	6.001.0078	Gun S'10Y	S		
	3.700.0025	RL 30 gun 3/8\"M - 1/4\"F (only for lance 6.602.0049-3.501.0032)		O	O
	4.618.0049	High pressure hose 8 m M22 - 3/8\"F		S	S
	4.018.0003	High pressure hose 8 m	S		
	6.002.0260	Lance with adjustable fan jet plus high/low pressur M 22 Ø 1,15		S	
	6.002.0241	Lance with adjustable fan jet plus high/low pressur M 22 Ø 1,20			O
	3.701.0015	700 mm lance 1/8\"F high/low press.		O	S
	6.602.0049	High-Low pressure lance 1700 mm - 1/4\" M (only for gun 3.700.0025)		O	O
	3.501.0032	2000 mm lance - 1/4\" M high/low press. (only for gun 3.700.0025)		O	O
	6.002.0202	Brass turbo lance LWS M22 1,1		O	
	6.002.0246	Brass turbo lance LWS M22 1,2			O
	6.002.0183	Lance with adjustable fan jet	S		
	6.602.0027	Sand blasting lance M22 040 WIDIA		O	O
	6.602.0177	Sand blasting lance	O		
	6.003.0015	6 m pipe-cleaning hose M22		O	O
	6.003.0018	10 m pipe-cleaning hose M22		O	O
	6.003.0037	6 m pipe-cleaning hose		O	
	6.003.0048	10 m pipe-cleaning hose		O	
	6.603.0004	Rotary brush M22		O	O
	6.002.0162	Foam sprayer lance	S		
	3.103.0035	Pipe-cleaning nozzle 3/8\"		O	O
	3.103.0048	High pressure nozzle 15035 1/8\"M		O	S
	4.606.0053	Quick hose coupling M22 - 3/8\" (Only for hose 4.618.0049)		O	O
	3.100.0082	Inlet quick coupling	S		
	3.102.0011	Water Filter 3/4 F - 3/4 M		O	O

S = standard equipment

O = optional



PROFESSIONAL LINE

Cold and hot water high-pressure cleaners

Efficiency, reliability, safety and ease of use are the basic factors for a careful selection of a professional product. On the ground of these standards, FA-SA has conceived professional line high-pressure cleaners, in order to match, through high-tech products, perfect hygiene and clean with time/labour saving.

Suitable for different uses and ideal in several sectors like: • Agriculture: cleaning and maintenance of machinery, farm tractors, stable and milking shed, silos and tanks. • Primary and secondary building: hard daily works as cleaning of earth-moving equipments, cranes, cement mixers; sand-blasting and cleaning of plasters and façades; • Petrol stations, motor shows and car-washing areas; • Cleaning contractors, where efficiency of FA-SA products reaches top of its versatility.

Cold water high-pressure cleaners

Onega-R



NEW



Standard equipment:



Watch the video on youtube:
www.youtube.com/fasavideo

Equipped with:

- Three steel pistons, brass axial pump head with built-in by-pass valve
- Total Stop
- Suction and delivery S/S valves
- Detergent built-in tank for indirect suction
- Pressure regulator
- Hose holder
- Accessory holder
- Ergonomic handle.

Onega-R 1409 XP

Code	8.661.0702
Operat. pressure bar	140 (max 180)
Operat. pressure psi	2030 (max 2610)
Delivery rate l/h	540
Absorbed power W	2800
RPM	2800
Voltage	230V~50Hz



Cold water high-pressure cleaners

Huron S

NEW

AUTOMATIC STOP



Standard equipment:



Watch the video on youtube:
www.youtube.com/fasavideo

Equipped with:

- Three steel pistons, brass axial pump head with built-in by-pass valve
- Suction and delivery S/S valves
- 1l detergent tank
- Accessory holder
- Ergonomic handle.

Huron S 1409 XP

Code	8.669.0005
Operat. pressure bar	140 (max 180)
Operat. pressure psi	2030 (max 2610)
Delivery rate l/h	540
Absorbed power W	2800
RPM	2800
Voltage	230V - 50Hz



Click!



Cold water high-pressure cleaners

Huron KA



Standard equipment:



Watch the video on youtube:
www.youtube.com/fasavideo

Equipped with:

- Three steel pistons, brass axial pump head with built-in by-pass valve.
- Total Stop.
- Suction and delivery S. S. valves.
- Detergent built-in tank for indirect suction.
- Power cable holder.
- Hose reel in pressure.
- Accessory holder.
- Ergonomic handle.
- 1l detergent tank

Huron KA 1409 XP

Code	8.669.0007
Operat. pressure bar	140 (max 180)
Operat. pressure psi	2030 (max 2610)
Delivery rate l/h	540
Absorbed power W	2800
RPM	2800
Voltage	230V~50Hz



Cold water high-pressure cleaners

Artic XP



Standard equipment:



Watch the video on youtube:
www.youtube.com/fasavideo

Equipped with:

- Three ceramic coated pistons, brass axial pump head with built-in by-pass valve.
- Total Stop.
- Suction and delivery S. S. valves.
- Detergent built-in tank for indirect suction.
- Pressure regulator.
- Glycerine pressure gauge.
- Hose reel.
- Accessory holder.
- Ergonomic handle.
- 4l detergent tank.

Artic XP 1211 XP

Code	8.613.0012
Operat. pressure bar	120 (max 150)
Operat. pressure psi	1740 (max 2175)
Delivery rate l/h	660 l/h
Absorbed power W	3300
RPM	2800
Voltage	230V~50Hz

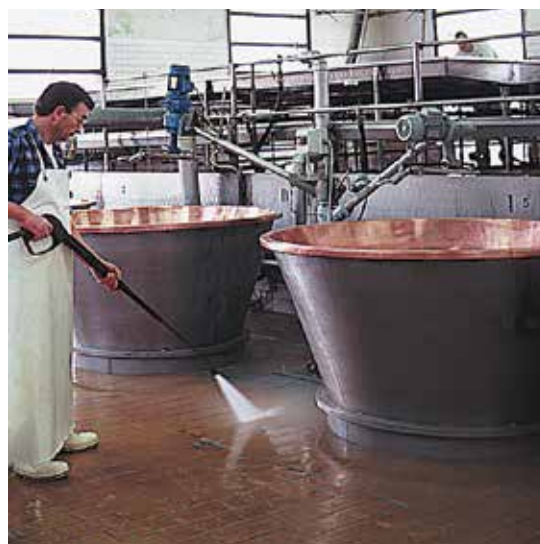

Cold water high-pressure cleaners

Caspian LP



Standard equipment:



Watch the video on youtube:
www.youtube.com/fasavideo

Equipped with:

- 4 poles electrical motor (1450 RPM) with thermal protection.
- Three ceramic coated pistons, brass linear pump head with built-in by-pass valve.
- Suction and delivery S. S. valves.
- Pressure regulator.
- Glycerine pressure gauge.
- Hose reel.
- Accessory holder.
- Ergonomic handle.
- 4l detergent tank

Caspian 1209 LP

Code	8.665.0116
Operat. pressure bar	120 (max 150)
Operat. pressure psi	1740 (max 2175)
Delivery rate l/h	510
Absorbed power W	2300
RPM	1450
Voltage	230V~50Hz



Cold water high-pressure cleaners

Tasman LP



Standard equipment:



3.700.0036 - mod. 1211 - 1509



3.700.0030 mod. 1713 - 2017



3.701.0027



3.103.0050 - mod. 1211
 3.103.0047 - mod. 1509
 3.103.0053 - mod. 1713
 3.103.0052 - mod. 2017



4.618.0049 - 8 m. mod. 1211 - 1509
 4.618.0143 - 10 m. mod. 1713 - 2017

Equipped with:

- 4 poles electrical motor (1450 RPM) with thermal protection and water cooling
- Three ceramic coated pistons, (full ceramic piston only for Tasman 1713) brass linear pump head with built-in by-pass valve.
- Suction and delivery S. S. valves.
- Low voltage and delayed Total Stop (three phase models)
- Detergent tank (2,8 lt.).
- Pressure regulator.
- Glycerine pressure gauge.
- Hose-reel (on request)



Watch the video on youtube:
www.youtube.com/fasavideo

	Tasman 1211 LP	Tasman 1509 LP	Tasman 1713 LP	Tasman 2017 LP
Code	8.671.0009	8.671.0010	8.671.0011	8.671.0012
Operat. pressure bar	120 (max 150)	150 (max 160)	170	200
Operat. pressure psi	1740 (max 2175)	2175 (max 2320)	2465	2900
Delivery rate l/h	660	540	780	1000
Absorbed power W	3000	3000	6000	7500
RPM	1450	1450	1450	1450
Voltage	230V~50Hz	230V~50Hz	400V~50Hz	400V~50Hz

Cold water high-pressure cleaners

Tasman XL LP



Standard equipment:

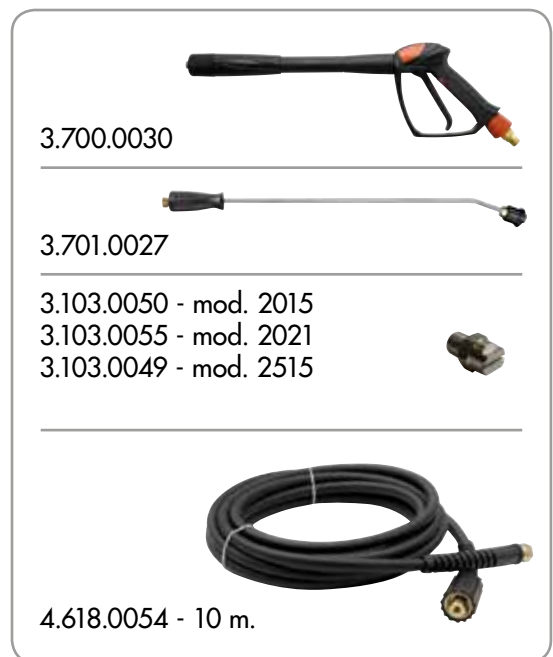

Equipped with:

- 4 poles electrical motor (1450 RPM) with thermal protection and water cooling.
- Three full ceramic pistons, brass linear pump head with by-pass valve.
- Low voltage and delayed Total Stop.
- Suction and delivery S. S. valves.
- Detergent built-in tank for indirect suction (2,8 lt.).
- Pressure regulator.
- Glycerine pressure gauge.
- Hose-reel



Watch the video on youtube:
www.youtube.com/fasavideo

	Tasman XL 2015 LP	Tasman XL 2021 LP	Tasman XL 2515 LP
Code	8.672.0004	8.672.0005	8.672.0006
Operat. pressure bar	200	200	250
Operat. pressure psi	2900	2900	3600
Delivery rate l/h	900	1260	900
Absorbed power W	7500	9400	8500
RPM	1450	1450	1450
Voltage	400V~50Hz	400V~50Hz	400V~50Hz

Cold water high-pressure cleaners

Explorer LP

Standard equipment:



Watch the video on youtube:
www.youtube.com/fasavideo

Equipped with:

- 4 poles electrical motor (1450 RPM) with thermal protection and water cooling.
- Three ceramic pistons, brass linear pump head with built-in by-pass valve.
- Suction and delivery S/S valves.
- Automatic Stop (late shut down protection 24V)
- Safety valve for overpressure.
- Integrated detergent suction with external suction probe
- Power cable (5 m)
- Pressure regulator
- Glycerine pressure gauge
- Tough steel main frame.



	Explorer 2015 LP	Explorer 2021 LP
Code	8.654.0020	8.654.0046
Operat. pressure bar	30÷200	30÷200
Operat. pressure psi	2900	2900
Delivery rate l/h	450÷900	630÷1260
Absorbed power W	7000	9400
RPM	1450	1450
Voltage	400V~50Hz	400V~50Hz

Cold water high-pressure cleaners with petrol engine

Clark 5H

POWERED by
HONDA



Watch the video on youtube:
www.youtube.com/fasavideo



Standard equipment:



3.700.0036



3.701.0027



3.103.0048



4.618.0049

8 m.

Equipped with:

- Three ceramic coated pistons brass axial pump head with built-in by-pass valve.
- Suction and delivery S/S valves.
- 5 HP Honda GP 160 unleaded gasoline engine.
- Integrated detergent suction with external suction probe.
- Pressure regulator.
- Glycerine pressure gauge.

Clark 5H

Code	8.601.0108
Operat. pressure bar	30÷160
Operat. pressure psi	2320
Delivery rate l/h	570
Engine type	Honda GP 160
Engine HP	5



Cold water high-pressure cleaners with petrol engine

Clark 11H



POWERED by
HONDA™

Standard equipment:



3.700.0030



3.701.0027



3.103.0053



4.618.0143 - 10 m.

Equipped with:

- Three ceramic pistons, brass linear pump head with builtin by-pass valve.
- Suction and delivery S/S valves.
- 11HP Honda GX unleaded gasoline engine.
- Integrated detergent suction with external suction probe.
- Pressure regulator.
- Automatic RPM regulation
- RPM reducer between engine and pump
- Glycerine pressure gauge.



Watch the video on youtube:
www.youtube.com/fasavideo

Optional:

- Steel frame Code 5.613.0145
- Professional hose reel Code 6.608.0060



Clark 11H

Code	8.601.0132
Operat. pressure bar	30÷200
Operat. pressure psi	2900
Delivery rate l/h	1080
Engine type	Honda GX 340
Engine HP	11

Cold water high-pressure cleaners with petrol engine

Clark 13H



POWERED by
HONDA

Standard equipment:



Equipped with:

- Three ceramic pistons, brass linear pump head with builtin by-pass valve.
- Suction and delivery S/S valves.
- 13HP Honda GX unleaded gasoline engine.
- Integrated detergent suction with external suction probe.
- Pressure regulator.
- Automatic RPM regulation
- RPM reducer between engine and pump
- Glycerine pressure gauge.



Watch the video on youtube:
www.youtube.com/fasavideo

Optional:

- Steel frame Code 5.613.0145
- Professional hose reel Code 6.608.0060



Clark 13H

Code	8.601.0158
Operat. pressure bar	30÷250
Operat. pressure psi	3625
Delivery rate l/h	1080
Engine type	Honda GX 390
Engine HP	13

Hot water high-pressure cleaners

Indian-R XP



Standard equipment:



Equipped with:

- Three ceramic coated pistons, brass axial pump head with built-in by-pass valve.
- Suction and delivery S. S. valves.
- Vertical burner with high thermal efficiency steel coil.
- Temperature regulation gauge.
- Diesel pump with by-pass valve.
- Detergent built-in tank for indirect suction.
- Pressure regulator.
- Glycerine pressure gauge.
- Power cable holder.
- Accessory holder.
- Ergonomic handle.



Watch the video on youtube:
www.youtube.com/fasavideo



Indian-R 1310 XP

Code	8.625.0102
Operat. pressure bar	130 (max 150)
Operat. pressure psi	1885
Delivery rate l/h	600
Temp. max	90°C
Power ass. W	3000
RPM	2800
Voltage	230V~50Hz

Hot water high-pressure cleaners

Desert XP



NEW

Standard equipment:



3.700.0036



3.701.0015



3.103.047



4.618.0049

8 m.

Equipped with:

- Three ceramic coated pistons, brass axial pump head with built-in by-pass valve.
- Low voltage and delayed Total Stop.
- Suction and delivery S. S. valves.
- Vertical burner with high thermal efficiency steel coil.
- Temperature regulation gauge.
- Low fuel lamp.
- Safety valve.
- Detergent built-in tank for indirect suction.
- Pressure regulator.
- Glycerine pressure gauge.
- Panel with analogic controls.
- Hose reel with brake (optional) hose not included code 6.608.0073



Watch the video on youtube:
www.youtube.com/fasavideo



Desert 1509 XP

Code	8.633.0110
Operat. pressure bar	150 (max 160)
Operat. pressure psi	2175
Delivery rate l/h	540
Temp. max	140°C
Power ass. W	3200
RPM	2800
Voltage	230V~50Hz

Hot water high-pressure cleaners

Sundek 5 XP



Standard equipment:



Equipped with:



Watch the video on youtube:
www.youtube.com/fasavideo

- Three ceramic coated pistons, brass axial pump head with built-in by-pass valve.
- Vertical burner with high thermal efficiency steel coil
- Suction and delivery S/S valves.
- Safety valve.
- Temperature regulation gauge.
- Glycerine pressure gauge.
- Automatic Stop System late shut down protection 24V.
- Adjustable detergent delivery with built-in tank for indirect suction.
- Two ways fuel pump
- Low fuel lamp.
- Ergonomic handles and impact resistant covers.
- Accessory holder.

Optional:

- Hose-reel with brake code 6.608.0001
- Header tank
- Antiscale LC-PRECAL (pcs. 4 x 5 lt. code 3.697.0044)



OPTIONAL

Hose reel with brake
 code 6.608.0001

	Sundek 5 1211 XP	Sundek 5 1511 XP
Code	8.620.0606	8.620.0607
Operat. pressure bar	30 ÷ 120	30 ÷ 150
Operat. pressure psi	1740	2175
Delivery rate l/h	330 ÷ 660	330 ÷ 660
Temp. max	140°C	140°C
Power ass. W	3200	4000
RPM	2800	2800
Voltage	230 V~50 Hz	400 V~50 Hz

Hot water high-pressure cleaners

Montigo LP

NEW



Standard equipment:

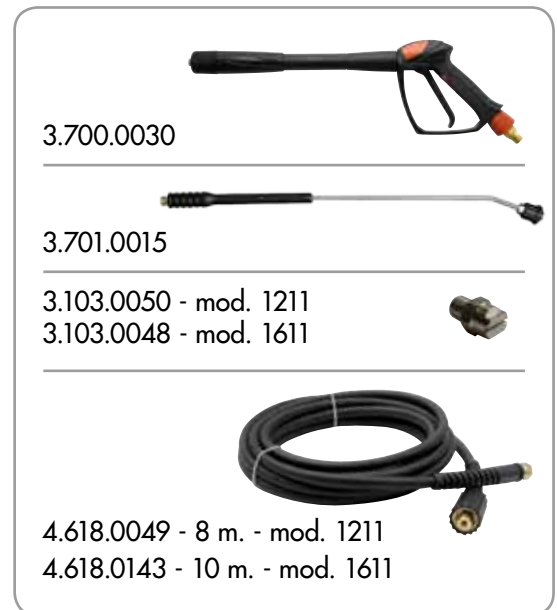

Optional:

- Hose reel with brake (optional) hose not included code 6.608.0073



Watch the video on youtube:
www.youtube.com/fasavideo

Equipped with:

- 4 poles electrical motor (1450 RPM) with thermal protection and water cooling (three phase models).
- Three ceramic coated pistons (1 ph), full ceramic pistons (3 ph), brass linear pump head with built-in by-pass valve.
- Low voltage and delayed Total Stop.
- Suction and delivery S. S. valves.
- Vertical burner with high thermal efficiency steel coil.
- Temperature regulation gauge with high sensitive stainless steel sensor.
- Detergent built-in tank for indirect suction.
- Auxiliary motor for burner.
- Hose reel with brake **(optional)**.



	Montigo 1211 LP	Montigo 1611 LP
Code	8.630.0105	8.630.0106
Operat. pressure bar	120 (max 150)	160
Operat. pressure psi	1740	2320
Delivery rate l/h	660	660
Temp. max	140°C	140°C
Power ass. W	3000	4300
RPM	1450	1450
Voltage	230 V~50 Hz	400 V~50 Hz

Hot water high-pressure cleaners

Sundek 5Y LP

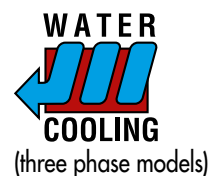

Standard equipment:



Equipped with:

- 4 poles electrical motor (1450 RPM) with thermal protection and water cooling (three phase models)
- Three ceramic coated pistons, brass linear pump head (1 ph), full ceramic pistons (3 ph), brass linear pump head with built-in by-pass valve
- Vertical burner with high thermal efficiency steel coil.
- Suction and delivery S/S valves. • Safety valve • Temperature regulation gauge • Glycerine pressure gauge. • Automatic Stop System late shut down protection 24V. • Adjustable detergent delivery with built-in tank for indirect suction. • Auxiliary motor for burner air-cooling • Two ways fuel pump • Low fuel lamp • Ergonomic handles and impact resistant covers • Accessory holder
- Power cable (m 5).

Optional:

- Hose-reel with brake code 6.608.0077
- Antiscale LC-PRECAL (pcs. 4 x 5 lt.) code 3.697.0044



Watch the video on youtube:
www.youtube.com/fasavideo

	Sundek 5Y 1311 LP	Sundek 5Y 1515 LP	Sundek 5Y 2015 LP
Code	8.621.2948	8.621.2942	8.621.2943
Operat. pressure bar	30 ÷ 110	30 ÷ 150	30 ÷ 200
Operat. pressure psi	1595	2175	2900
Delivery rate l/h	330 ÷ 660	450 ÷ 900	450 ÷ 900
Temp. max	140°C	140°C	140°C
Power ass. W	3000	5500	7300
RPM	1450	1450	1450
Voltage	230 V~50 Hz	400 V~50 Hz	400 V~50 Hz

Hot water high-pressure cleaners

Maxima LP



Standard equipment:



Equipped with:

- 4 poles electrical motor (1450 RPM) and thermal protection and water cooling
- Three ceramic pistons, brass linear pump head with built-in by-pass valve
- Suction and delivery S/S valves.
- Automatic Stop System late shut down protection 24V
- Vertical burner with high thermal efficiency
- Header tank with antiscal tank
- Adjustable detergent delivery with built-in tank for direct suction (high-pressure delivery).
- Auxiliary motor for burner air-cooling and two ways fuel pump
- Glycerine pressure gauge
- Power cable (m 5)
- Temperature regulation gauge
- Gun with swivel hose fitting
- Low voltage control switches
- Tough steel main frame

Optional:

- Hose-reel with brake without hose code 6.608.0005
- Antiscal LC-PRECAL (pcs. 4 x 5 lt.) code 3.697.0044



Watch the video on youtube:
www.youtube.com/fasavideo

	Maxima 1515 LP	Maxima 2015 LP
Code	8.622.0903	8.622.0904
Operat. pressure bar	30 ÷ 150	30 ÷ 200
Operat. pressure psi	2175	2900
Delivery rate l/h	450 ÷ 900	450 ÷ 900
Temp. max	140° C	140° C
Power ass. W	5500	7300
RPM	1450	1450
Voltage	400V~50 Hz	400V~50 Hz



Hot water high-pressure cleaners

Maxima XXL LP



Standard equipment:

3.700.0030



3.708.0001



3.103.0058 - mod. 1521
3.103.0055 - mod. 2021



4.618.0056 - 10 m.



Equipped with:



Watch the video on youtube:
www.youtube.com/fasavideo

- 4 poles electrical motor (1450 RPM) with thermal protection and water cooling
- Three ceramic pistons, brass linear pump head with separate by-pass valve
- Main pump components are interchangeable with some other pump manufacturer
- Suction and delivery S/S valves
- Automatic Stop System late shut down protection 24V
- Vertical burner with high thermal efficiency (>90%) designed for high flow rates
- Anti-scale device with refilling tank
- Adjustable detergent delivery with built-in tank for direct suction (high-pressure delivery)
- Auxiliary motor for burner air-cooling and two ways fuel pump.
- Power cable (m 5)
- Temperature regulation gauge
- Gun with swivel hose fitting
- Low tension control switches
- Tough steel main frame

Optional:

- Hose-reel with brake without hose code 6.608.0005
- Antiscale LC-PRECAL (pcs. 4 x 5 lt.) code 3.697.0044

	Maxima XXL 1521 LP	Maxima XXL 2021 LP
Code	8.623.0923	8.623.0914
Operat. pressure bar	30 ÷ 150	30 ÷ 200
Operat. pressure psi	2175	2900
Delivery rate l/h	630 ÷ 1260	630 ÷ 1260
Temp. max	140° C	140° C
Power ass. W	7300	9700
RPM	1450	1450
Voltage	400V~50Hz	400V~50Hz



Hot water high-pressure cleaner with combustion engine

Clark Hot 10

Hot water self-contained unit



LOMBARDINI
A KOHLER COMPANY

Standard equipment:



Equipped with:



Watch the video on youtube:
www.youtube.com/fasavideo

- Hot water self-contained unit
- Electrical start with full engine functions control
- Lombardini diesel engine 15LD400 (air cooling)
- Three ceramic pistons, brass linear pump head with separated by-pass valve
- Suction and delivery S/S valves
- Thermal safety valve on the bypass line
- Max water inlet temperature 40° C.
- Pumpmotor gearbox (1650 RPM).
- Auxiliary belt driven sturdy alternator
- Automatic engine RPM regulator
- Integrated detergent suction with external suction probe
- Pressure regulator.
- Glycerine pressure gauge.
- Unique diesel tank for engine and burner
- Tough steel main frame

Optional:

- S/S header tank (high pressure chemical)
- Varnished soundproofing steel cover set code 6.608.0014
- Trolley set with inflateable wheels & handles code 6.608.0020



Clark Hot 10

Code	8.601.0109
Operat. pressure bar	30±170
Operat. pressure psi	2465
Delivery rate l/h	1020
Max water temperature	140° C
RPM pump	1650
Engine type	Lombardini diesel
Engine HP	10

Hot water high-pressure cleaner with combustion engine

Clark Hot 17

Hot water self-contained unit with integrated electric generator



Standard equipment:



Equipped with:

- Hot water self-contained unit with integrated electric generator and max 1,5 kW fixed socket.
- 17 HP Lombardini 2 cylinder water cooled diesel engine with electric start, complete with panel with engine function led and automatic power cut-off.
- Three ceramic pistons, brass linear pump head with separated by-pass valve.
- Suction and delivery S/S valves.
- Max water inlet temperature 40° C.
- Belt driven pump (1450 RPM).
- Automatic engine RPM regulator
- Manual power control
- Loose by-pass outlet
- Pressure regulator.
- Glycerine pressure gauge.
- Flow rate regulator
- Unique diesel tank for engine and burner
- Tough steel main frame



- Available on request sound proofing steel model: CLARK HOT 17 SILENCED

Clark Hot 17

Code	8.601.0052
Operat. pressure bar	30±200
Operat. pressure psi	2900
Delivery rate l/h	1320
Max water temperature	30±140° C
RPM pump	1600
Engine type	Lombardini diesel
Engine HP	17

Accessories for high-pressure cleaners

			MONTEGO 1611 LP	MONTEGO 1211 LP	DESERT 1509 XP	URON 1409 KA	URON 1409 S	OMEGA 1309 XP	ARTIC 1211 XP	CASPIAN 1209 LP	TASHMAN 1211 LP	TASHMAN 1509 LP	TASHMAN 1713 LP	TASHMAN 2017 LP	TASHMAN XL 2015 LP	TASHMAN XL 2021 LP	TASHMAN XL 2515 LP	EXPLORER 2015 LP	EXPLORER 2021 LP	CLARK SH	CLARK 11H	CLARK 13H	INDIAN R 1310 XP	SUNDEK 5 1211 XP	SUNDEK 5 1511 XP	SUNDEK 5 1811 Y LP	SUNDEK 5 1515 Y LP	SUNDEK 5 2015 Y LP	MAXIMA 1515 LP	MAXIMA 2015 LP	MAXIMA XXL 1521 LP	MAXIMA XXL 2021 LP	CLARK HOT 10	CLARK HOT 17				
	6.001.0107	Gun 1/4" - M 22					S	S																														
	3.700.0036	Gun 3/8" - M22			S	S			S	S	S	S								S			S															
	3.700.0025	Gun RL 30 3/8" M - 1/4" F (only for lance 6.602.0049 - 6.602.0050 - 3.701.0020)	O	O	O	O	O	O	O	O	O	O	O	O	O	O	O	O	O	O	O	O	O	O	O	O	O	O	O	O	O	O	O	O	O	O	O	
	3.700.0030	Gun PRO 3/8" M - M 22	S	S								S	S	S	S	S	S	S	S	S	S	S	S	S	S	S	S	S	S	S	S	S	S	S	S	S		
	4.618.0049	Hose A.P. 8 m - 3/8" - M22 - Ø 1/4"		S	S						S	S								S		S																
	4.618.0143	Hose A.P. 10 m - 3/8" - Ø 5/16" with quick rounded connection 3/8" - 310 bar	S									S	S					S	S		S	S		S	S	S	S	S	S	S	S	S	S	S	S	S		
	4.618.0012	Hose A.P. 10 m - 3/8" - Ø 5/16" - 310 bar	O						O	O			O	O	O	O	O	O	O	O	O	O	O	O	O	O	O	O	O	O	O	O	O	O	O	O	O	
	4.618.0056	Hose A.P. 20 m - 3/8" - Ø 5/16" - 400 bar							O	O			O	O	O	O	O	O	O	O	O	O	O	O	O	O	O	O	O	O	O	O	O	O	O	O	O	
	4.618.0057	Hose A.P. 20 m - 3/8" - Ø 3/8" - 400 bar							O	O			O	O	O	O	O	O	O	O	O	O	O	O	O	O	O	O	O	O	O	O	O	O	O	O	O	
	4.618.0058	Hose A.P. for food industry m.10 - 3/8" - Ø 3/8" - 400 bar							O	O			O	O	O	O	O	O	O	O	O	O	O	O	O	O	O	O	O	O	O	O	O	O	O	O	O	
	4.618.0059	Hose A.P. for steam - 3/8" - Ø 3/8" MAX 135°C							O	O			O	O	O	O	O	O	O	O	O	O	O	O	O	O	O	O	O	O	O	O	O	O	O	O	O	
	4.618.0128	Hose A.P. 8 m - Ø 1/4 - M22 - 1/4"					S	S																														
	4.618.0053	Hose A.P. 10 m - 3/8" - 3/8" - Ø 1/4"				O			S	S																												
	4.618.0090	Hose A.P. 8 m - 3/8" - Ø 1/4" - 210 bar				S			O	O																												
	4.618.0054	Hose A.P. 10 m - 3/8" - Ø 5/16 - 310 bar	O						O	O			O	O	S	S	S	O	O	O	O	O	O	O	O	O	O	O	O	O	O	O	O	O	O	O	O	
	6.608.0001	Hose reel kit (without hose) for SUNDEK																						O	O													
	6.608.0004	Hose reel kit (without hose) for SUNDEK Y																								O	O	O										
	6.608.0005	Hose reel kit (without hose) for MAXIMA																																				
	6.608.0071	Wall mount hose reel kit (without hose)						O	O	O	O	O	O	O	O	O	O	O	O	O	O	O	O	O	O	O	O	O	O	O	O	O	O	O	O	O	O	O
	6.608.0068	Hose reel kit (without hose) for EXPLORER																	O	O																		
	3.749.0508	Wall mount hose reel kit (without hose) Painted	O	O	O	O	O	O	O	O	O	O	O	O	O	O	O	O	O	O	O	O	O	O	O	O	O	O	O	O	O	O	O	O	O	O	O	O
	3.749.0509	Wall mount hose reel kit with hose h.p. 30 m - 3/8 - Ø 5/16 - 310 bar Painted	O	O	O	O	O	O	O	O	O	O	O	O	O	O	O	O	O	O	O	O	O	O	O	O	O	O	O	O	O	O	O	O	O	O	O	O
	3.749.0510	Wall mount hose reel kit (without hose) Stainless steel	O	O	O	O	O	O	O	O	O	O	O	O	O	O	O	O	O	O	O	O	O	O	O	O	O	O	O	O	O	O	O	O	O	O	O	O
	6.602.0035	Professional fixed brush M22	O	O	O	O	O	O	O	O	O	O	O	O	O	O	O	O	O	O	O	O	O	O	O	O	O	O	O	O	O	O	O	O	O	O	O	O
	6.602.0036	Professional rotary brush M22	O	O	O	O	O	O	O	O	O	O	O	O	O	O	O	O	O	O	O	O	O	O	O	O	O	O	O	O	O	O	O	O	O	O	O	O
	6.603.0004	Rotary brush M22	O	O	O	O	O	O	O	O	O	O	O	O	O	O	O	O	O	O	O	O	O	O	O	O	O	O	O	O	O	O	O	O	O	O	O	O
	3.100.0043	3/8" M rotating quick coupling	O						O	O			O	O	O	O	O	O	O	O	O	O	O	O	O	O	O	O	O	O	O	O	O	O	O	O	S	S
	3.100.0023	3/8"- 3/8" hose coupling				O									O	O	O																					
	4.606.0053	3/8"- M22 hose coupling		O	O				O	O	O	O									O		O															
	4.006.0062	1/4" - M22 hose coupling					O	O																														
	3.100.0018	1/2"- 3/8" hose coupling	O									O	O					O	O		O	O		O	O	O	O	O	O	O	O	O	O	O	O	O	O	

S = Standard equipment O = Optional

Accessories for high-pressure cleaners

			MONTIGO 1611 LP	MONTIGO 1211 LP	DESERT 1509 XP	URON 1409 KA	URON 1409 S	OMEGA 1309 XP	ARTIC 1211 XP	CASPIAN 1209 LP	TASMAN 1211 LP	TASMAN 1509 LP	TASMAN 1713 LP	TASMAN 2017 LP	TASMAN XL 2015 LP	TASMAN XL 2021 LP	TASMAN XL 2515 LP	EXPLORER 2015 LP	EXPLORER 2021 LP	CLARK SH	CLARK 11H	CLARK 13H	INDIAN R 1310 XP	SUNDEK S 1211 XP	SUNDEK S 1511 XP	SUNDEK S 1311 Y LP	SUNDEK S 1515 Y LP	SUNDEK S 2015 Y LP	MAXIMA 1515 LP	MAXIMA 2015 LP	MAXIMA XXI 1521 LP	MAXIMA XXI 2021 LP	CLARK HOT 10	CLARK HOT 17					
	3.701.0015	mm 700 high/low press. lance 1/8" (for detergent suction) stainless steel	S	S	S																		S	S	S										S				
	3.708.0001	mm 700 lance 1/8" with nozzle holder																								S	S	S	S	S	S	S	S			S			
	3.701.0027	mm 600 high/low press. lance 1/8" (for detergent suction)				S			S		S	S	S	S	S	S	S	S	S	S	S	S																	
	6.602.0322	M22 lance with nozzle holder + 5.012.0281 5 nozzle					S	S		S																													
	6.602.0038	M22 lance with nozzle holder + 5.012.0281 5 nozzle					O	O		O																													
	6.602.0049	mm 1700 1/4" M - 1/8" F high/low press. (for detergent suction) lance (only for gun 3.700.0025)	O1	O1	O1	O1	O1	O1	O1	O1	O1	O1	O1	O1	O1	O1	O1	O1	O1	O1	O1	O1	O1	O1	O1	O1	O1	O1	O1	O1	O1	O1	O1	O1	O1	O1	O1	O1	
	6.602.0050	mm 1700 1/4" M - 1/8" F lance (only for gun 3.700.0025)	O1	O1	O1	O1	O1	O1	O1	O1	O1	O1	O1	O1	O1	O1	O1	O1	O1	O1	O1	O1	O1	O1	O1	O1	O1	O1	O1	O1	O1	O1	O1	O1	O1	O1	O1	O1	
	3.701.0020	mm 1050 S/S lance with nozzle-holder 1,4" M connection (only for gun 3.700.0025)																																					
	6.602.0040	Lance turbo type 1 M22 - 045			O		O	O	O	O	O	O	O	O	O	O	O	O	O	O	O	O	O	O	O	O	O	O	O	O	O	O	O	O	O	O	O	O	
	6.602.0041	Lance turbo type 2 M22 - 055											O									O																	
	6.602.0042	Lance turbo mm 500 M22 - 07															O																						
	6.602.0056	Lance turbo mm 500 M22 - 0,35	O		O	S												O					O																
	6.602.0003	Foam lance M22 max 90°C	O	O	O	O	O	O	O	O	O	O	O	O	O	O	O	O	O	O	O	O	O	O	O	O	O	O	O	O	O	O	O	O	O	O	O	O	
	6.602.0010	Foam lance M22 with plastic bottle 1l. max 90°C	O	O	O	O	O	O	O	O	O	O	O	O	O	O	O	O	O	O	O	O	O	O	O	O	O	O	O	O	O	O	O	O	O	O	O	O	O
	6.602.0055	High pressure foam lance M22 max 60°C (Nozzle Ø 0,45)	O	O	O	O	O	O	O	O	O	O	O	O	O	O	O	O	O	O	O	O	O	O	O	O	O	O	O	O	O	O	O	O	O	O	O	O	
	6.602.0053	High pressure foam lance M22 with plastic bottle 1l. max 60°C (Nozzle Ø 0,45)	O	O	O	O	O	O	O	O	O	O	O	O	O	O	O	O	O	O	O	O	O	O	O	O	O	O	O	O	O	O	O	O	O	O	O	O	
	3.103.0035	3/8" Professional pipe cleaning nozzle	O	O	O	O			O	O	O	O	O	O	O	O	O	O	O	O	O	O	O	O	O	O	O	O	O	O	O	O	O	O	O	O	O	O	
	6.608.0054	Professional pipe cleaning nozzle 10 m - M22	O	O	O	O	O	O	O	O	O	O	O	O	O	O	O	O	O	O	O	O	O	O	O	O	O	O	O	O	O	O	O	O	O	O	O	O	O
	6.608.0045	Professional pipe cleaning nozzle 20 m - M22	O	O	O	O	O	O	O	O	O	O	O	O	O	O	O	O	O	O	O	O	O	O	O	O	O	O	O	O	O	O	O	O	O	O	O	O	O
	3.102.0011	Water filter 3/4" F - 3/4" M 80 microns	O	O	O	O	O	O	O	O	O	O	O	O	O	O	O	O	O	O	O	O	O	O	O	O	O	O	O	O	O	O	O	O	O	O	O	O	
	6.602.0021	S/S hose/gun quick coupling set 3/8" - 3/8"	O	O	O	O	O	O	O	O	O	O	O	O	O	O	O	O	O	O	O	O	O	O	O	O	O	O	O	O	O	O	O	O	O	O	O	O	
	6.608.0003	3/8" - 3/8" brass hoses/guns quick coupling set	O	O	O	O			O	O	O	O	O	O	O	O	O	O	O	O	O	O	O	O	O	O	O	O	O	O	O	O	O	O	O	O	O	O	O
	6.608.0002	1/4" - 1/4" brass hoses/guns quick coupling set					O	O																															
	6.602.0027	M22 040 Widia sand-blasting lance	O	O	O	O	O	O	O	O	O					O	O						O	O	O	O													
	6.602.0028	M22 050 Widia sand-blasting lance										O	O														O												
	6.602.0029	M22 - 075 Widia sand-blasting lance														O			O																		O	O	

S = standard equipment O = optional O1 = in combination with M22 nipple code 4.006.0099

Accessories for high-pressure cleaners



ROTOX HEAD

	3.103.0027 h.p. nozzle .30	3.103.0037 h.p. nozzle .35	3.103.0028 h.p. nozzle .40	3.103.0034 h.p. nozzle .45	3.103.0029 h.p. nozzle .50	3.103.0030 h.p. nozzle .55	3.103.0031 h.p. nozzle .60	3.103.0024 h.p. nozzle .65	3.103.0070 h.p. nozzle .75	3.103.0033 h.p. nozzle .90	3.103.0047 h.p. nozzle .30	3.103.0048 h.p. nozzle .35	3.103.0049 h.p. nozzle .40	3.103.0050 h.p. nozzle .45	3.103.0051 h.p. nozzle .50	3.103.0052 h.p. nozzle .55	3.103.0053 h.p. nozzle .60	3.103.0054 h.p. nozzle .65	3.103.0055 h.p. nozzle .70	3.103.0058 h.p. nozzle .85	3.103.0018 h.p. nozzle .30	3.103.0020 h.p. nozzle .35	3.103.0009 h.p. nozzle .40	3.103.0016 h.p. nozzle .45	3.103.0017 h.p. nozzle .50	3.103.0019 h.p. nozzle .55	3.103.0021 h.p. nozzle .60	3.103.0066 h.p. nozzle .65	3.103.0067 h.p. nozzle .70	3.103.0069 h.p. nozzle .90	3.749.0200 rotary nozzle max 90° G1/F-040	3.749.0201 rotary nozzle max 90° G1/F-045	3.749.0202 rotary nozzle max 90° G1/F-050	3.749.0203 rotary nozzle max 90° G1/F-055	3.749.0204 rotary nozzle max 90° G1/F-060	3.749.0205 rotary nozzle max 90° G1/F-065	3.749.0206 rotary nozzle max 90° G1/F-070	3.749.0263 rotary nozzle max 90° G1/F-090				
HURON KA		○									S											○														○						
ARTIC XP			○									S		S									○													○						
TASMAN 1211 LP			○									S		S									○													○						
TASMAN 1509 LP	○										S												○														○					
TASMAN 1713 LP RA							○									S																					○					
TASMAN 2017 LP RA						○									S													○										○				
TASMAN XL 2015 LP RA			○										S											○														○				
TASMAN XL 2021 LP RA								○						S					S						○													○				
TASMAN XL 2515 LP RA			○										S										○															○				
EXPLORER 2015 LP RA			○										S											○														○				
EXPLORER 2021 LP RA								○						S					S						○													○				
CLARK 5 H		○										S											○																○			
CLARK 11 H							○									S																							○			
CLARK 13 H						○									S										○															○		
INDIAN-R XP	○											S										○																	○			
DESERT XP	○											S										○																		○		
SUNDEK 5 1211 XP			○										S											○															○			
SUNDEK 5 1511 XP			○										S											○																○		
MONTIGO 1211 LP			○										S											○																○		
MONTIGO 1611 LP	○											S											○																	○		
SUNDEK 5Y 1311 LP			○										S											○																○		
SUNDEK 5Y 1515 LP RA					○									S											○															○		
SUNDEK 5Y 2015 LP RA			○											S										○																○		
MAXIMA 1515 LP RA						○								S		S										○														○		
MAXIMA 2015 LP RA			○											S											○															○		
MAXIMA XXL 1521 LP RA										○									S		S					○														○		
MAXIMA XXL 2021 LP RA										○									S		S					○														○		
CLARK HOT 10							○											S									○													○		
CLARK HOT 17								○										S									○													○		



Accessories for high-pressure cleaners

Foam lance



Foam lance max 250 bar:
foam lance max temperature 90° C.
For gun M 22

6.602.0003	Foam lance
6.602.0010	Foam lance with plastic bottle 1l.

Foam lance



Foam lance max 180 bar:
max temperature 60° C
High pressure foam lance with regulator.
For gun M 22

6.602.0055	Foam lance
6.602.0053	Foam lance with plastic bottle 1l.



Calibrated sand
6 pieces of 5 kg each

Calibrated sand for sand-blasting lances

0.011.0001	6 pieces of 5 kg each
------------	-----------------------



Double lance with regulator knob max 250 bar:
for high/low pressure regulator, max temperature 150° C,
for gun M 22 (nozzles 1/8" not included)

Double lances

3.701.0025	Double lance with regulator knob mm 500
------------	-----------------------------------------

Water flow adjuster coupling



Code	Inlet		Outlet		Max. pressure			Flow rate		Temperature	
	A	B	bar	psi	MPa	l/m	GPM	°C	°F		
3.703.0023	M22 Ø14	M22F Ø14	280	4061	28	30	7.93	160	320		
3.703.0024	1/4" M	M22F Ø14	280	4061	28	30	7.93	160	320		
3.703.0009	1/4" M	1/4" F	280	4061	28	30	7.93	160	320		

Pipe cleaning nozzles

	Code	Description	Thread	Type
	3.103.0035	Pipe cleaning nozzle with side holes	3/8" M	0.55
	3.103.0106	Rounded head pipe cleaning nozzle	3/8" M	0.55
	3.103.0107	Pipe cleaning nozzle with side holes	3/8" F	0.55
	3.103.0119	Pipe cleaning nozzle with side holes	1/4" F	0.55

Accessories for high-pressure cleaners



Gun with extensible telescopic lance

Code :
4.018.0067
Spare hose

Code :
3.100.0021
Coupling 1/4"M-1/4"M

Code :
3.100.0022
Coupling 1/4"M-3/8"M

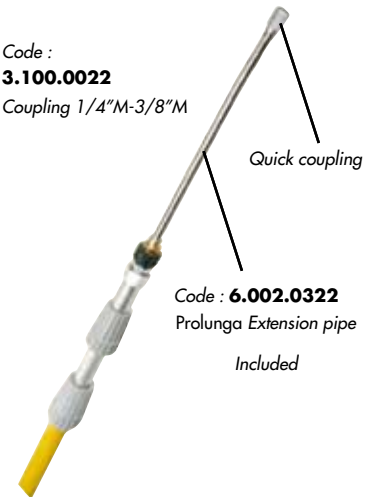
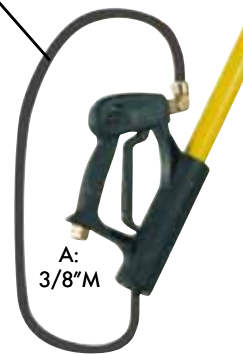

Code	Pressure			Flow rate		Length		Coupling	Temperature	
	bar	psi	MPa	l/m	GPM	min. mm	max. mm		A	°C
3.749.0488	250	3625	25	40	10.5	2000	5000	3/8"M	150	302

Quick coupling code: 4.607.0275 + adapter for nozzle 1/4" code: 3.100.0032

Quick coupling code: 4.607.0275 + adapter for nozzle 1/8" code: 3.100.0338



High pressure hoses

Code	Max. pressure			Length	Ø	Inlet	Outlet	Max. temperature
	bar	psi	MPa					
4.618.0153	310	4496	31	20	5/16"	1/2"F	3/8"F	150
4.618.0056	400	5801	40	20	5/16"	3/8"F	3/8"F	150
4.618.0057	400	5801	40	20	3/8"	3/8"F	3/8"F	150



For food industry

Food hose R2 with rubber hose bend Ø 3/8"

Code	Max. pressure			Length	Inlet	Outlet	Max. temperature
	bar	psi	MPa				
4.618.0058	400	5801	40	10	3/8"F	3/8"F	150



For food industry

Steam hose R2 with rubber hose bend Ø 3/8"

Code	Max. pressure			Length	Inlet	Outlet	Max. temperature
	bar	psi	MPa				
4.618.0059	400	5801	40	10	3/8"F	3/8"F	135



PROFESSIONAL LINE

High-pressure pumps units
Complete boilers for high-pressure cleaners

FA-SA's offering of pumps and motor pumps intentionally targets a clientele seeking top quality and durability for this kind of products:

- Forged brass pump head: improved mechanical strength, superior resistance to corrosion and oxidation phenomena.
- Nickel plated forged brass (CW5) pump head: the perfect surface finish, jointly with the properties of the plating, assure improved resistance to chemicals and lower chance of deterioration caused by cavitation phenomena.
- Valves with stainless steel plate and spherical seal: high fluid dynamics performance.
- Ceramic pistons (according to the models): to assure longer service life of the pistons and guarantee lower wear of water seals and improved resistance to thermal shocks.

High-pressure pumps units

CL4 series

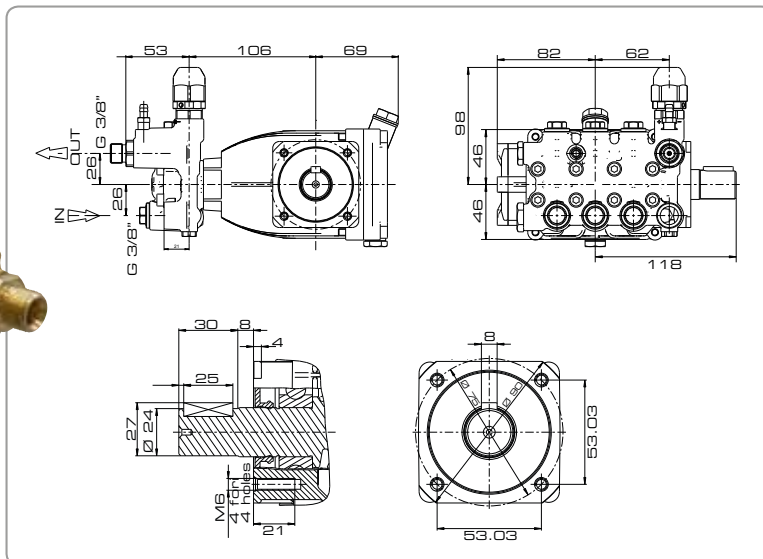

Equipped with:

- Pressure adjuster included

Model	Right shaft ver.		Left shaft ver.		RPM	Max. pressure			Flow rate		Requested power			Weight				
	Code	Code	Code	Code		bar	psi	MPa	l/m	GPM	HP	kW	kg	lbs				
CL 44-15 9-200	5.702.0018	5.702.0019	5.702.0019	5.702.0018	1450	200	2900	20	9	11	2.4	2.9	4,9	6	3,6	4,4	6,6	14,5
CL 44-15 11-200	5.702.0020	5.702.0021	5.702.0021	5.702.0020	1450	200	2900	20	11	13	2.9	3.5	6	6,5	4,4	4,8	6,6	14,5
CL 44-18 15-200	5.703.0006	5.703.0007	5.703.0007	5.703.0006	1450	200	2900	20	15	18	4	4.7	7,5	9,2	5,5	6,9	7	15,4

CL5 series

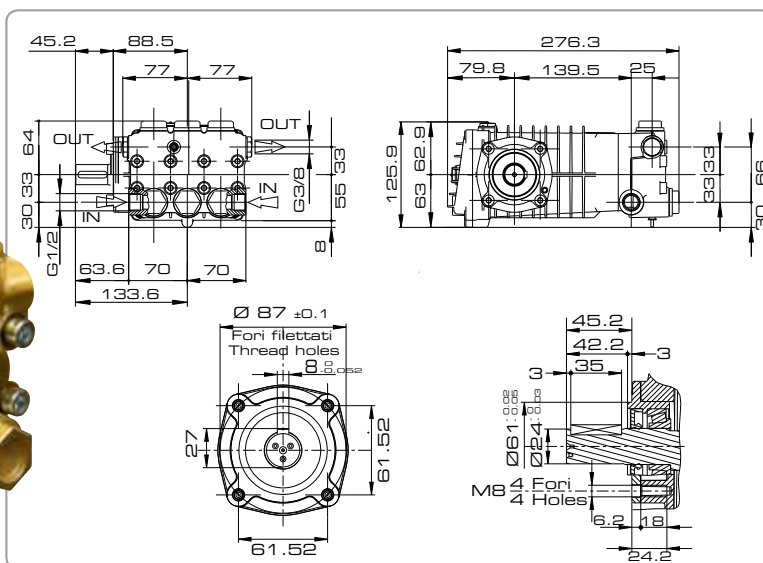

Model	Right shaft ver.		Left shaft ver.		RPM	Max. pressure			Flow rate		Requested power			Weight				
	Code	Code	Code	Code		bar	psi	MPa	l/m	GPM	HP	kW	kg	lbs				
CL 54-20 11-200	6.605.0183	6.605.0184	6.605.0184	6.605.0183	1450 1750	200	2900	20	11	13	2.9	3.5	6	6,5	4,4	4,8	9,8	21,6
CL 54-20 15-200	6.605.0185	6.605.0186	6.605.0186	6.605.0185	1450 1750	200	2900	20	15	18	4	4.7	7,5	9,2	5,5	6,9	9,8	21,6
CL 54-20 21-200	6.605.0187	6.605.0188	6.605.0188	6.605.0187	1450 1750	200	2900	20	21	25	5.5	6.6	10,5	12,8	7,7	9,5	9,8	21,6

High-pressure pumps units

CW5 series (Nickel plated CL5)

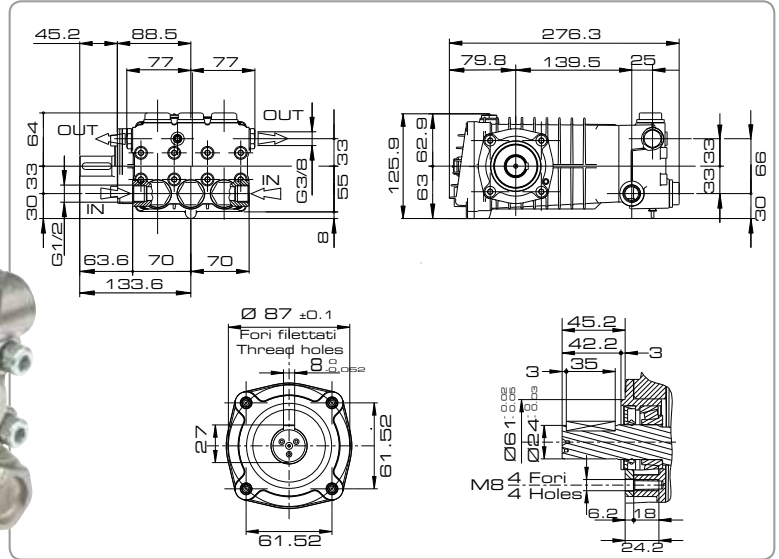

Model	Right shaft ver.		Left shaft ver.		RPM			Max. pressure			Flow rate		Requested power				Weight	
	Code	Code			bar	psi	MPa	l/m	GPM	HP	kW		kg	lbs				
CW 54-20 11-200	6.605.0192	6.605.0193	1450	1750	200	2900	20	11	13	2.9	3.5	6	6,5	4,4	4,8	9,8	21,6	
CW 54-20 15-200	6.605.0194	6.605.0195	1450	1750	200	2900	20	15	18	4	4.7	7,5	9,2	5,5	6,9	9,8	21,6	
CW 54-20 21-200	6.605.0196	6.605.0197	1450	1750	200	2900	20	21	25	5.5	6.6	10,5	12,8	7,7	9,5	9,8	21,6	

MPBX1 series (Omnia 12 Pump)

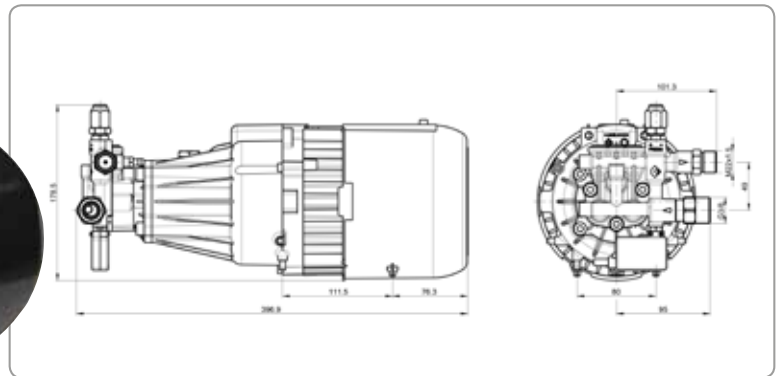
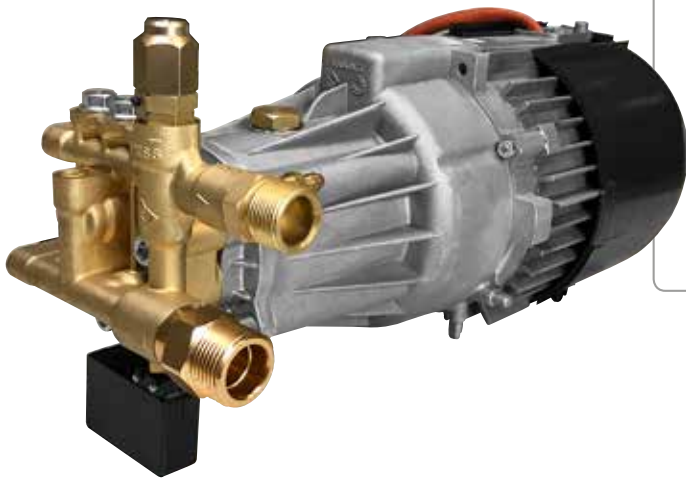

Equipped with: • High-pressure motor pumps units • Fixing bracket included

Model	Left shaft ver.	RPM	Max. pressure			Flow rate		Requested power	Power supply	Weight	
	Code		bar	psi	MPa	l/m	GPM	kW		kg	lbs
MPBX 1-12 9-140	on request	2800	140	2030	14	9	2.37	2.8	1 Ph 230V~50Hz	13	28,6
MPBX 1-12 9-140	on request	3400	140	2030	14	9	2.37	2.8	1 Ph 220V~60Hz	13	28,6

High-pressure pumps units

MPBX2 series (Omnia 15 Pump)

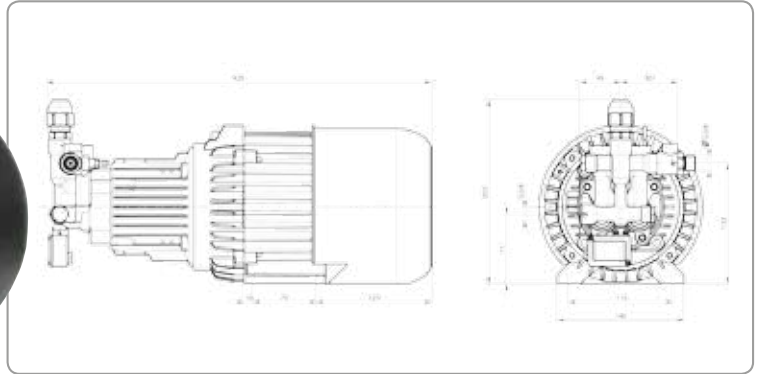
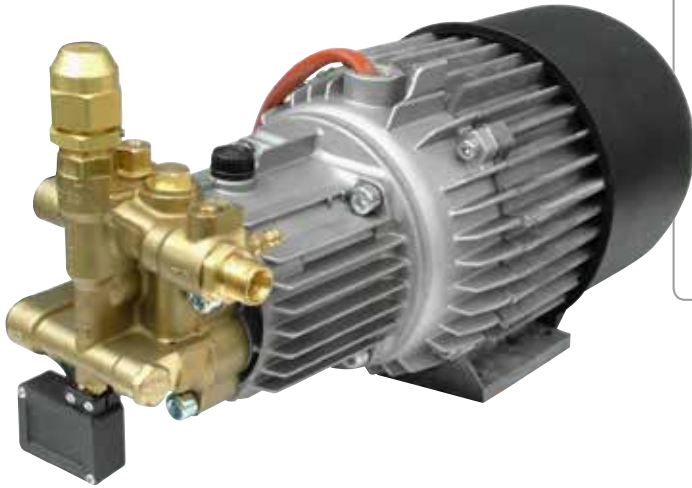

Equipped with: • High-pressure motor pumps units • Fixing bracket included

Model	Left shaft ver. Code	RPM	Max. pressure			Flow rate		Requested power kW	Power supply	Weight	
			bar	psi	MPa	l/m	GPM			kg	lbs
MPBX 2-15 11-120	8.680.0046	2800	120	1740	12	11	2.9	3	1Ph 230V~50Hz	20,5	45,2
MPBX 2-15 07-200	8.680.0049	2800	200	2900	20	7	1.8	3	1Ph 230V~50Hz	21	46,2
MPBX 2-15 11-150	8.680.	2800	150	2175	15	11	2.9	4	3Ph 400V~50Hz	21	46,2

MPW5 series

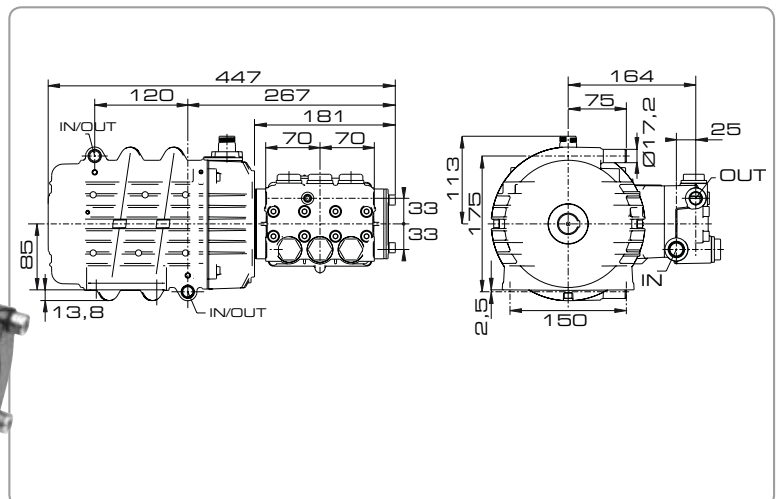

Equipped with: • Fixing bracket included

Model	Left shaft ver. Code	RPM	Max. pressure			Flow rate		Requested power kW	Power supply	Weight	
			bar	psi	MPa	l/m	GPM			kg	lbs
MPW 54-20 15-150	8.680.0022	1450	150	2175	15	15	4	5	3Ph Y 400V~50Hz	32	70,5
MPW 54-20 15-200	8.680.0023	1450	200	2900	20	15	4	7	3Ph Y 400V~50Hz	34	74,9

High-pressure pumps units

MPWJ5 series

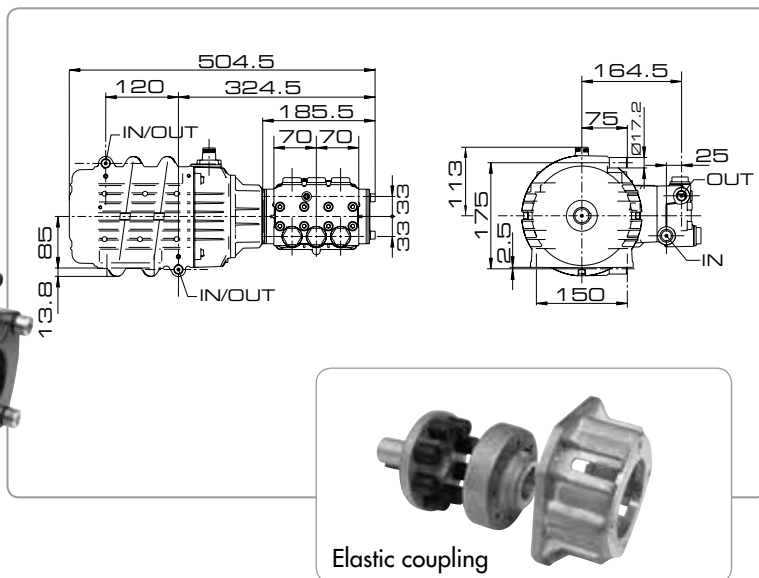

Equipped with: • High-pressure pumps units with elastic coupling • Fixing bracket included

Model	Left shaft ver. Code	RPM	Max. pressure			Flow rate		Requested power kW	Power supply	Weight	
			bar	psi	MPa	l/m	GPM			kg	lbs
MPWJ 54-20 15-150	8.680.0028	1450	150	2175	15	15	4	5	3Ph Y 400V~50Hz	32,5	71,6
MPWJ 54-20 15-200	8.680.0029	1450	200	2900	20	15	4	7	3Ph Y 400V~50Hz	34,5	76
MPWJ 54-20 21-200	8.680.0030	1450	200	2900	20	21	5,5	9,4	3Ph Y 400V~50Hz	37,5	82,6

MP4 series

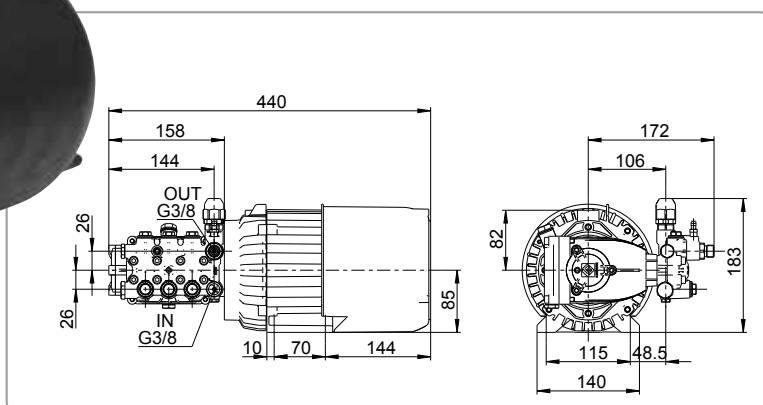

Equipped with: • Pressure adjuster included

Model	Left shaft ver. Code	RPM	Max. pressure			Flow rate		Requested power kW	Power supply	Weight	
			bar	psi	MPa	l/m	GPM			kg	lbs
MP 34-15 11-120	8.680.0100	1450	120	1740	12	11	2,9	3	1Ph 230V~50Hz	22	49,2
MP 34-15 11-120	8.680.0101	1750	120	1740	12	11	2,9	3	1Ph 220V~60Hz	22	49,2
MP 34-15 11-150	8.680.0102	1450	150	2175	15	11	2,9	4	3Ph Y 400V~50Hz	22,5	49,6
MP 34-15 11-150	8.680.0103	1750	150	2175	15	11	2,9	4	3Ph Y 400V~60Hz	22,5	49,6

High-pressure pumps units

MPJ4 series

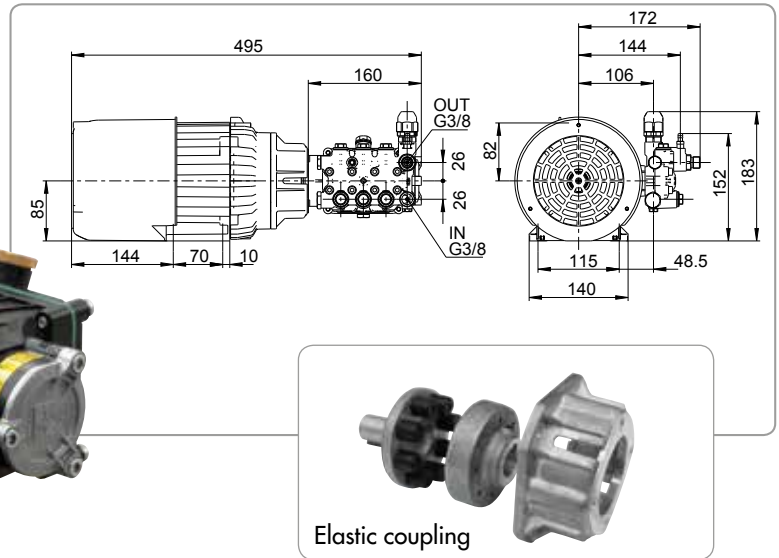
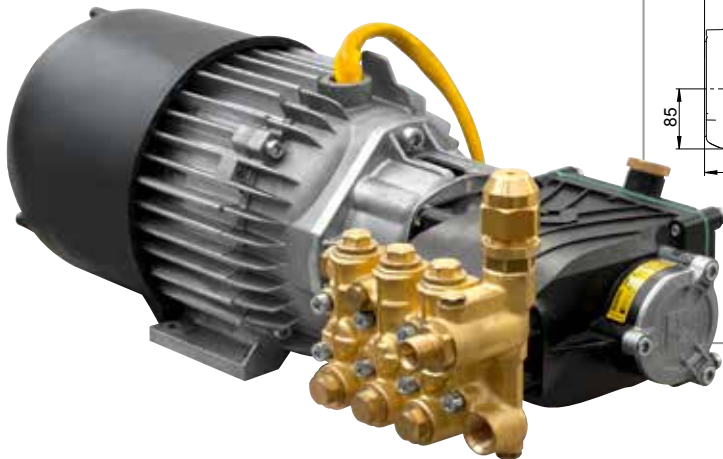

Equipped with: • High-pressure pumps units with elastic coupling • Pressure adjuster included

Model	Left shaft ver. Code	RPM	Max. pressure			Flow rate		Requested power kW	Power supply	Weight	
			bar	psi	MPa	l/m	GPM			kg	lbs
MPJ 34-15 11-120	8.680.0104	1450	120	1740	12	11	2,9	3	1Ph 230V~50Hz	22,5	49,6
MPJ 34-15 11-120	8.680.0105	1750	120	1740	12	11	2,9	3	1Ph 220V~60Hz	22,5	49,6
MPJ 34-15 15-150	8.680.0106	1450	150	2175	15	11	2,9	4	3Ph Y 400V~50Hz	23	50,6
MPJ 34-15 15-150	8.680.0107	1750	150	2175	15	11	2,9	4	3Ph Y 400V~60Hz	23	50,6

MPW4 series

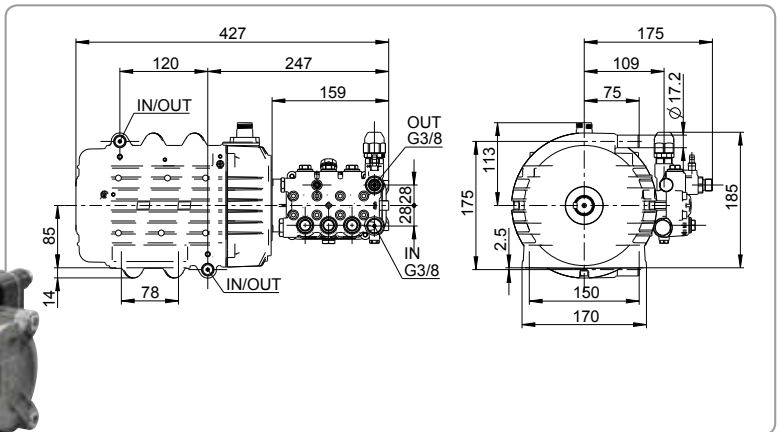

Equipped with: • Fixing bracketed included • Pressure adjuster included

Model	Left shaft ver. Code	RPM	Max. pressure			Flow rate		Requested power kW	Power supply	Weight	
			bar	psi	MPa	l/m	GPM			kg	lbs
MPW 34-18 15-150	8.680.0108	1450	150	2175	15	15	4	5	3Ph Y 400V~50Hz	28,8	63,5
MPW 34-18 15-200	8.680.0109	1450	200	2900	20	15	4	7	3Ph Y 400V~50Hz	30,8	67,9
MPW 34-15 13-200	8.680.0110	1750	200	2900	20	13	3,4	8,4	3Ph Y 400V~60Hz	28,5	62,8

High-pressure pumps units

MPWJ4 series

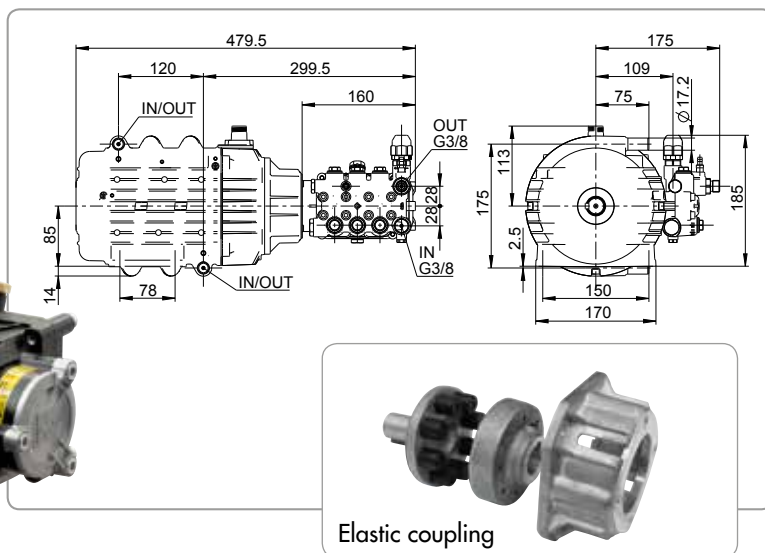

Equipped with: • High-pressure pumps units with elastic coupling • Fixing bracket included • Pressure adjuster included

Model	Left shaft ver. Code	RPM	Max. pressure			Flow rate		Requested power kW	Power supply	Weight	
			bar	psi	MPa	l/m	GPM			kg	lbs
MPWJ 34-18 15-150	8.680.0043	1450	150	2175	15	15	4	5	3Ph Y 400V~50Hz	29,3	64,6
MPWJ 34-18 15-200	8.680.0044	1450	200	2900	20	15	4	7	3Ph Y 400V~50Hz	31,3	69
MPWJ 34-15 13-200	8.680.0045	1750	200	2900	20	13	3,4	8,4	3Ph Y 400V~60Hz	29	63,9

Top/High/Low series

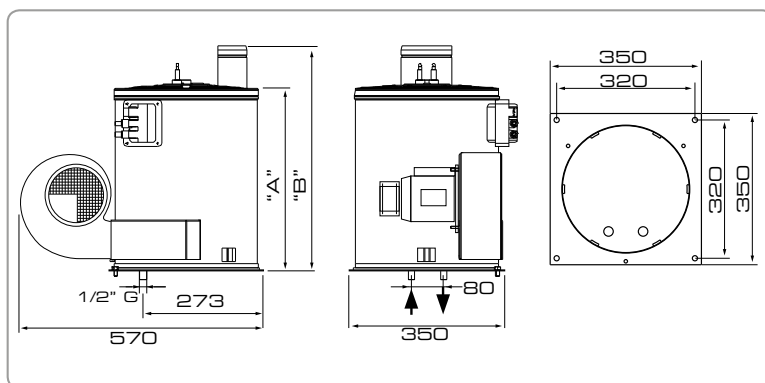

(*) Available in various voltages

Equipped with:

- Complete boilers for high-pressure cleaners

Model	Code	Max. pressure			Flow rate		Requested power W	Power sup. (*)	Thermal power	Coil length	Dimension	Weight	
		bar	psi	MPa	l/m	GPM						kg	lbs
Top	8.690.0010	200	2900	20	12	3.17	300	230V ~ 50Hz	49000 Kcal/h	20 m	405 mm (A) - 510 mm (B)	38	85,9
Low	8.690.0001	200	2900	20	15	3.96	300	230V ~ 50Hz	63000 Kcal/h	29,5 m	465 mm (A) - 565 mm (B)	48,5	106,8
High	8.690.0002	200	2900	20	21	5.55	300	230V ~ 50Hz	63000 Kcal/h	36,5 m	600 mm (A) - 690 mm (B)	54	120

Complete boilers for high-pressure cleaners

High 08/Low 08 series

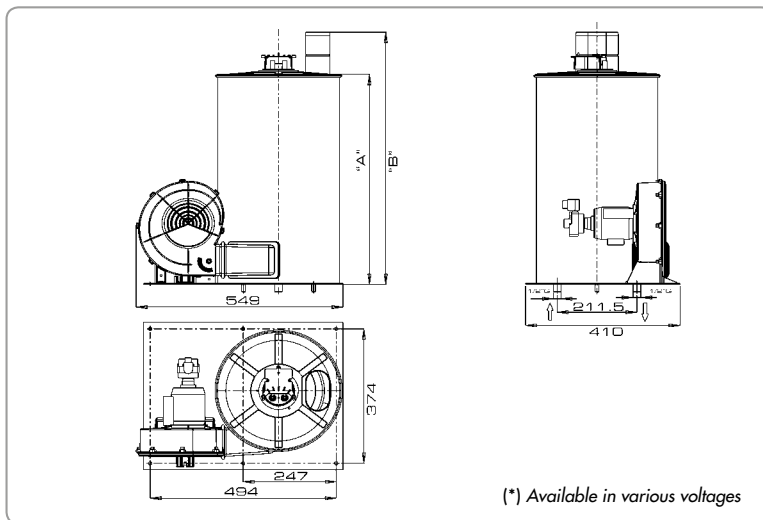

Equipped with:

- Complete boilers for high-pressure cleaners

Model	Code	Max. pressure			Flow rate		Requested power W	Power sup. (*)	Thermal power	Coil length	Dimension	Weight	
		bar	psi	MPa	l/m	GPM						kg	lbs
Low 08	8.690.0069	200	2900	20	15	3.96	300	230V ~ 50Hz	49.000 Kcal/h	28 m	471 mm (A) - 587 mm (B)	50	110,2
High 08	8.690.0070	200	2900	20	21	5.55	300	230V ~ 50Hz	73.500 Kcal/h	34 m	586 mm (A) - 702 mm (B)	62,4	137,5



LAVORWASH
SERVICE

www.lavorservice.com

The new LAVORSERVICE catalogue code 7.199.1090 is now available, offering a wide range of accessories and universal spare parts compatible with most important branded products on the market.

Moreover, to support the daily job of our partners, we created a special software providing information on: standard accessories supplied of all LAVORWASH products since 1975 and set for ordinary and extraordinary maintenance.

The software can be freely downloaded from the website:
www.lavorwash.com/Sales_Support/lavorservice.

A person wearing a white t-shirt and dark pants is cleaning the interior of a car. They are using a vacuum cleaner with a long hose and a motor unit on the floor. The car's seats are visible, and the person is leaning over the driver's side seat. The entire image has a blue tint.

HOBBY LINE

Wet & dry vacuum cleaners

FA-SA domestic line of wet & dry vacuum cleaners and carpet cleaners is specially designed to provide a practical effective answer to cleaning requirements in household as well as in working and institutional places.

For houses, DIY , vehicles, workshops, offices, public premises, hotels, hospitals, schools, cleaning contractors, FA-SA makes available powerful and reliable products, with innovative design, easy to handle, user friendly and compact.

But, above all, safe as they comply with the European standards and are approved by the world's most demanding certificate Corporations.

FA-SA wet & dry vacuum cleaners are equipped with a full set of useful and interchangeable accessories, so that they are suitable to any specific requirement.

Wet & dry vacuum cleaners

WS 20

PNEUMATIC FILTER SHAKER



Blowing function

Standard equipment:

2 x 3.753.0072	
3.754.0249	
3.754.0005	
3.753.0121	
5.212.0030	
5.212.0101	

Equipped with:

- Silenced motor
- Double electrical insulation
- Suction system with bypass cooling system
- Blowing function (blower)
- Accessory holders
- Steel tank
- Cable holder
- Pneumatic filter shaker



WS 20

Code	8.243.0008
Motor W	1000 (max 1200)
Column depress. mbar	180
Tank capacity l.	20
Suction air l/s	30
Voltage	220-240V~50/60Hz

Wet & dry vacuum cleaners

GTX 32 E



AUTOMATIC ON/OFF



max **2200 W**

With socket for power tools (max 2200 W)



Watch the video on youtube:
www.youtube.com/fasavideo

Standard equipment:

2 x
3.753.0009



3.754.0191



3.754.0188



3.754.0005



5.209.0059



5.212.0049



5.212.0030



5.212.0029





Equipped with:

- Silenced motor
- Suction system with by-pass coolings
- S/S tank
- Large accessory holder
- Static electric shock inhibitor.
- Shock proof trolley with accessory holder.
- Liquid float valve.
- Plug for electric tools max 2200 W

GTX 32 E

Code	8.228.0062
Motor W	1400 (max 1600)
Column depress. mbar	270
Tank capacity l.	30
Suction air l/s	70
Voltage	220-240V~50/60Hz

Accessories for vacuum cleaners

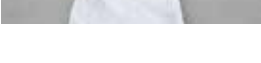
			WS 20	GTX 32 E
	3.753.0121	1,5 m - Ø 35 mm flexible hose with curve	S	
	5.209.0059	4 m - Ø 35 mm flexible hose		S
	3.753.0072	0,45 m extension pipe Ø 35 mm	S	O
	3.753.0009	0,5 m chromium-plated steel extension pipe Ø 35 mm	O	S
	3.753.0013	0,5 m/0,9 m telescopic steel extension pipe Ø 35 mm	O	O
	3.754.0249	Multipurpose nozzle for wet & dry suction	S	
	3.754.0188	Holder for floor accessories		S
	6.205.0117	Holder for floor accessories + 3 brushes	O	
	3.754.0191	Bristle/liquids brush		S
	3.754.0190	Accessory for liquids		O
	3.754.0013	Carpet brush	O	O
	3.754.0016	Combined brush (floor-carpet-lower part steel)	O	O
	3.754.0015	Ø 35 round brush	O	O
	3.754.0004	Ø 35 nozzle	O	O
	3.754.0005	Ø 35 flat lance	S	S
	5.212.0045	Brush for radiators	O	O
	5.212.0044	Multidiameter tool adapter Ø 35÷27	O	O
	5.212.0029	Cartridge filter	O	S
	5.212.0037	HEPA filter	O	O
	5.212.0040	Washable filter	O	O
	5.212.0030	Sponge filter	S	S
	5.212.0049	5 paper collector bags set (3.752.0203)		S
	5.212.0005	10 paper filters set (code 3.752.0006)	O	
	5.209.0009	Cloth filter		O
	5.212.0092	Nylon filter		O
	5.212.0101	3 fabric filters set (code 3.752.0237)	S	O

S = Standard equipment O = Optional



COMMERCIAL LINE

Wet & dry vacuum cleaners

WINDY range is the new line of commercial vacuum cleaners suitable for wet and dry applications: three models equipped with 2 or 3 professional single stage motor (from 2,4 up to 3,6 kW), stainless steel or anti shock plastic tank, tilting or fixed tank: WINDY are mainly designed for daily light industrial use and are perfectly suited to the most common demand of cleaning contractors, garages, workshops etc...

They are equipped with the new manual RF (reverse flow) filter cleaning system, granting high cleaning efficiency and longer lifespan of the motors. Practical in every situation, the new WINDY range offers accessories holder, cable holder and a new rotating ON/OFF switch, simple and resistant to daily use.

Equipped with professional accessories and professional filter (HEPA available), WINDY is the answer to your requests!

Dry vacuum cleaners

Echo

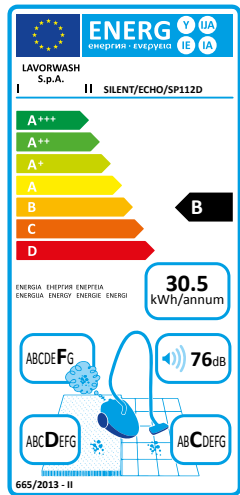

NEW



Equipped with:

- Silenced single stage motor (high efficiency).
- Integrated accessory holder.
- Shock and overturn proof design.
- 12 litre plastic tank (PP)
- Cloth filter
- Rotating ON/OFF switch
- Paper collector filter.

Standard equipment:

5.209.0210	
6.205.0187	
3.754.0005	
3.754.0015	
3.754.0263	
3.754.0004	
3.752.0115	
5.209.0207	

Optional:

- code. 5.212.0023 Paper collector filter set (10 pcs)
- code. 5.212.0149 Microfiber collector filter set (10 pcs)
- code. 6.205.0199 Paper collector filter set (300 pcs)
- code. 6.205.0200 Paper collector filter set (550 pcs)
- code. 5.212.0163 HEPA filter
- code. 3.754.0081 Brush carpet Turbo brush



Echo

Code	8.246.0002
Motore W	800 W
Column depress.	24 kPa/2400 mm H ₂ O
Tank capacity	12 l.
Suction air	44 l/s
Voltage	230V-240V~50-60Hz











Wet & dry vacuum cleaners

Windy 120 IF

NEW



Standard equipment:

5.209.0077	
6.205.0109	
3.754.0005	
3.754.0015	
3.754.0168	 300 mm
3.754.0169	
3.754.0170	
3.754.0004	
3.752.0114	
3.752.0175	
5.209.0009	

Equipped with:

- High efficiency by pass motor.
- Suction system with by-pass cooling.
- S. S. tank.
- Shock proof trolley.
- Liquid float valve.
- Cloth filter.
- 7,5 m power cable.
- Accessories Ø 35.
- Handy accessory holder.

Windy 120 IF

Code	8.249.0001
N°motors - power (max)	1 - 1200 (1400) W
Column depress.	24 kPa/2400 mm H ₂ O
Tank capacity	20 l.
Suction air	65 l/s
Voltage	220V-240V~50-60Hz

Optional:

- code. 5.212.0022 Paper collector filter set
- code. 5.212.0043 Cloth filter
- code. 3.754.0205 Brush floor/carpet with wheels
- code. 5.212.0029 Cartridge filter
- code. 5.212.0037 HEPA filter
- code. 5.212.0040 Washable filter
- code. 3.754.0081 Brush carpet Turbo brush













Watch the video on youtube:
www.youtube.com/fasavideo

Wet & dry vacuum cleaners

Windy 130 IF



Standard equipment:

5.209.0077	
6.205.0109	
3.754.0005	
3.754.0015	
3.754.0168	 300 mm
3.754.0169	
3.754.0170	
3.754.0004	
3.752.0114	
3.752.0175	
5.212.0040	

Equipped with:

- High efficiency by pass motor.
- Suction system with by-pass cooling.
- S. S. tank.
- Shock proof trolley.
- Liquid float valve.
- Cloth filter.
- 7,5 m power cable.
- Accessories Ø 35.
- Handy accessory holder.

Windy 130 IF

Code	8.250.0001
N°motors - power (max)	1 - 1200 (1400) W
Column depress.	24 kPa/2400 mm H ₂ O
Tank capacity	30 l.
Suction air	65 l/s
Voltage	220V-240V~50-60Hz

Optional:

- code. 5.212.0022 Paper collector filter set
- code. 5.212.0043 Cloth filter
- code. 3.754.0205 Brush flor/carpet with wheels
- code. 5.212.0029 Cartridge filter
- code. 5.212.0037 HEPA filter
- code. 5.212.0040 Washable filter
- code. 3.754.0081 Brush carpet Turbo brush











Watch the video on youtube:
www.youtube.com/fasavideo

Wet & dry vacuum cleaners

Windy 265 PF



Standard equipment:

5.209.0021	
6.205.0126	
3.754.0049	
3.754.0048	
3.754.0083	 400 mm
3.754.0084	
3.754.0085	
6.205.0151	

Equipped with:

- 2 high efficiency by pass motors. • Suction system with by-pass cooling.
- Filter cleaning system. • Plastic tank (PP). • Static electric shock inhibitor.
- Shock proof trolley. • Liquid float valve. • Cloth filter. • 7,5 m power cable. • Traceless wheels. • Accessories Ø 40. • Handy accessory holder.

Windy 265 PF

Code	8.239.0008
N°motors - power (max)	2 - 2000 (2400) W
Column depress.	22 kPa/2200 mm H ₂ O
Tank capacity	65 l.
Suction air	130 l/s
Voltage	220V-240V ~ 50-60Hz

Optional:

- code. 5.212.0022 Paper collector filter set
- code. 5.209.0177 Cloth filter for fine dust
- code. 5.212.0093 Nylon filter











Watch the video on youtube:
www.youtube.com/fasavideo

Wet & dry vacuum cleaners

Windy 265 IF



Standard equipment:

5.209.0021	
6.205.0126	
3.754.0049	
3.754.0048	
3.754.0083	 400 mm
3.754.0084	
3.754.0085	
6.205.0151	

Equipped with:

- 2 high efficiency by pass motors. • Suction system with by-pass cooling.
- Filter cleaning system. • S/S tank. • Static electric shock inhibitor. • Shock proof trolley. • Liquid float valve. • Cloth filter. • 7,5 m power cable. • Traceless wheels. • Accessories Ø 40. • Handy accessory holder.

Windy 265 IF

Code	8.239.0001
N°motors - power (max)	2 - 2000 (2400) W
Column depress.	22 kPa/2200 mm H ₂ O
Tank capacity	65 l.
Suction air	130 l/s
Voltage	220V-240V ~ 50-60Hz

Optional:

- code. 5.212.0022 Paper collector filter set
- code. 5.209.0177 Cloth filter for fine dust
- code. 5.212.0093 Nylon filter











Watch the video on youtube:
www.youtube.com/fasavideo

Wet & dry vacuum cleaners

Windy 365 IR



Standard equipment:

5.209.0021	
6.205.0126	
3.754.0049	
3.754.0048	
3.754.0083	 400 mm
3.754.0084	
3.754.0085	
6.205.0151	

Equipped with:

- 3 high efficiency by pass motors
- Suction system with by-pass cooling
- Filter cleaning system
- S/S tank
- Static electric shock inhibitor
- Tilting tank
- Fully removable tank
- Shock proof trolley
- Liquid float valve
- Cloth filter
- 7,5 m power cable
- Traceless wheels
- Accessories Ø 40
- Handy accessory holder.

Windy 365 IR

Code	8.240.0001
N° motors - power (max)	3 - 3000 (3600) W
Column depress.	22 kPa/2200 mm H ₂ O
Tank capacity	65 l.
Suction air	195 l/s
Voltage	220V-240V ~ 50-60Hz

Optional:

- code. 5.212.0022 Paper collector filter set
- code. 5.209.0177 Cloth filter for fine dust
- code. 5.212.0093 Nylon filter



Watch the video on youtube:
www.youtube.com/fasavideo









Wet & dry vacuum cleaners

Windy 278 IF

NEW



Standard equipment:

5.209.0021	
6.205.0126	
3.754.0049	
3.754.0048	
3.754.0083	 400 mm
3.754.0084	
3.754.0085	
6.509.2176	

Equipped with:

- 2 high efficiency by pass motors. • Suction system with by-pass cooling.
- Filter cleaning system. • S. S. tank. • Static electric shock inhibitor. • Shock proof trolley. • Liquid float valve. • Cloth filter. • 7,5 m power cable. • Traceless wheels. • Accessories Ø 40. • Handy accessory holder.

Windy 278 IF

Code	8.247.0001
N°motors - power (max)	2 - 2000 (2400) W
Column depress.	22 kPa/2200 mm H ₂ O
Tank capacity	78 l.
Suction air	130 l/s
Voltage	220V-240V ~ 50-60Hz

Optional:

- code. 5.212.0022 Paper collector filter set
- code. 5.509.1405 Cloth filter for fine dust
- code. 5.212.0093 Nylon filter



Watch the video on youtube:
www.youtube.com/fasavideo









Wet & dry vacuum cleaners

Windy 378 IR

NEW



Standard equipment:

5.209.0021	
6.205.0126	
3.754.0049	
3.754.0048	
3.754.0083	
3.754.0084	
3.754.0085	
6.509.2176	

Equipped with:

- 3 high efficiency by pass motors. • Suction system with by-pass cooling. • Filter cleaning system. • S. S. tank. • Static electric shock inhibitor. • Tilting tank. • Fully removable tank. • Shock proof trolley. • Liquid float valve. • Cloth filter. • 7,5 m power cable. • Traceless wheels. • Accessories Ø 40. • Handy accessory holder.

Optional:

- code. 5.212.0022 Paper collector filter set
- code. 5.509.1405 Cloth filter for fine dust
- code. 5.212.0093 Nylon filter

Windy 378 IR

Code	8.248.0001
N°motors - power (max)	3 - 3000 (3600) W
Column depress.	22 kPa/2200 mm H ₂ O
Tank capacity	78 l.
Suction air	195 l/s
Voltage	220V-240V ~ 50-60Hz



Watch the video on youtube:
www.youtube.com/fasavideo

Wet & dry vacuum cleaner and injection/extraction with foam cleaning device

Windy IE Foam

NEW



Equipped with:

- 2 high efficiency by-pass motors
- Suction system with by-pass cooling
- Stainless steel tank
- Detergent pump (48W - 1 l/m - 15 bar)
- Steel closing hooks
- Static electric shock inhibitor
- Fully removable tank
- 12 l. detergent tank
- Shock proof trolley
- Safety floating
- Washable cartridge filter
- 7,5 m power cable
- Traceless wheels
- Accessories Ø 40
- Equipped with connection for compressed air and pressure gauge with pressure adjuster for foam cleaning.

Standard equipment:

5.209.0021	
6.205.0197	
6.205.0205	
6.402.0108	
6.402.0109	
2 x 5.211.0102	
5.212.0141	
3.754.0048	
3.697.0072	LC Prefoam

Optional:

- 5.212.0022 - Paper collector filter set -10 pcs
- 5.209.0177 - Cloth filter for fine dust
- 5.212.0093 - Nylon filter
- 0.110.0020 - Antifoam device
- 3.697.0036 - Anti-foaming for recovery tank
- 3.697.0058 - (4x5 Kg) Acid-based det. for toilets
- 3.697.0057 - (4x5 Kg) Alkaline-based det. alimentary environments
- 3.697.0056 - (4x5 Kg) Det. for fabrics and carpeting



Watch the video on youtube:
www.youtube.com/fasavideo

Windy IE Foam

Code	8.239.0017
N° motors - power (max)	2 - 2000 (2400) W
Column depress.	22 kPa/2200 mm H ₂ O
Tank capacity	65 l.
Suction air	130 l/s
Voltage	220V-240V ~ 50-60Hz



PROFESSIONAL LINE

Wet & dry vacuum cleaners









The new Professional range of Lavor PRO vacuum cleaners provides the solution for every kind of heavy duty daily use. The models of the wet and dry series are equipped with 1 up to 3 double stage motor (1.2 to 3.6 kW), different tank capacities (20-35-50 and 78 l.), tilting or fixed tank and PPL antishock or stainless steel tanks. Designed to be user friendly, they are equipped with ergonomic handle, big wheels and stable trolley offering the final answer to the needs of cleaning contractors, industries, workshops, car washing station etc. The accessories sets allowing all the different operation of wet and dry suction, are designed to be stressless for the end user (using longer extension pipes) and can easily fit and change quickly one to the other. The antishock feature has to be considered a big advantage when metal dust, flour and all the different types of dirt creating ESD electrostatic discharge are collected inside the tank. This feature avoids shocks to the end user, making usage easier. Wide cloth filter bag (standard) grants good performances of the motor also when it is used for a long period; HEPA, cartridge, nylon, sponge and collector bag can be equipped easily (Optional). The filter area is reachable easily and the wide float seat grants stability on the floor during filter cleaning session. The ANTIFOAM device (optional) must be used in case of mixture chemical/water suction, avoiding the foam to reach motor.

Wet & dry vacuum cleaners

Domino 53 Inox



Standard equipment:

5.209.0021	
6.205.0126	
3.754.0049	
3.754.0048	
3.754.0185	
3.754.0169	
3.754.0170	
6.205.0011	
6.205.0008	

Equipped with:

- Silenced two stages motor
- Suction system with by-pass cooling
- S/S tank
- Power cable 10 mt
- Professional closing hooks
- Static electric shock inhibitor
- Shock proof trolley
- Easy standing head (during filter cleaning)
- Liquid float valve

Domino 53 Inox

Code	8.215.0504
N°motors - power (max)	1 - 1200 (1400) W
Column depress.	22 kPa/2200 mm H ₂ O
Tank capacity	50 l.
Suction air	53 l/s
Voltage	220V-240V ~ 50-60Hz

Optional:

- code. 5.212.0022 Paper collector filter set
- code. 5.212.0094 Nylon filter
- code. 5.212.0020 Washable filter
- code. 5.212.0006 Cartridge filter
- code. 5.212.0010 HEPA filter











Watch the video on youtube:
www.youtube.com/fasavideo

Wet & dry vacuum cleaners

Domino 78 Inox



Standard equipment:

5.209.0021	
6.205.0126	
3.754.0049	
3.754.0048	
3.754.0083	 400 mm
3.754.0084	
3.754.0085	
5.509.0039	

Equipped with:

- 2 Silenced two stage Motor
- Professional closing hooks
- Suction system with by-pass cooling
- S/S tank
- Liquid float valve
- 10 m power cable
- Static electric shock inhibitor
- Shock proof trolley
- Ergonomic handle tank, head and trolley
- Easy standing head (during filter cleaning)

Domino 78 Inox

Code	8.216.0504
N°motors - power (max)	2 - 2000 (2400) W
Column depress.	22,4 kPa/2240 mm H ₂ O
Tank capacity	78 l.
Suction air	108 l/s
Voltage	220V-240V ~ 50-60Hz

Optional:

- code. 5.212.0022 Paper collector filter set
- code. 5.509.1405 Cloth filter for fine dust
- code. 5.212.0093 Nylon filter
- code. 5.212.0021 Washable filter
- code. 5.212.0034 HEPA filter











Watch the video on youtube:
www.youtube.com/fasavideo

Wet & dry vacuum cleaners

Domino 78 Inox BS



Standard equipment:

5.209.0021	
6.205.0126	
3.754.0049	
3.754.0048	
3.754.0083	 400 mm
3.754.0084	
3.754.0085	
5.509.0039	

Equipped with:

- 2 Silenced two stage Motor
- Professional closing hooks
- Suction system with by-pass cooling
- S/S tank
- Tilting tank
- Fully removable tank
- Plastic handle
- Liquid float valve
- Power cable 10 mt
- Cable holder
- Ergonomic handle tank, head and trolley
- Shock proof trolley
- Easy standing head (during filter cleaning)
- Static electric shock inhibitor

Domino 78 Inox BS

Code	8.213.0502
N°motors - power (max)	2 - 2000 (2400) W
Column depress.	22,4 kPa/2240 mm H ₂ O
Tank capacity	78 l.
Suction air	108 l/s
Voltage	220V-240V ~ 50-60Hz

Optional:

- code. 5.212.0022 Paper collector filter set
- code. 5.509.1405 Cloth filter for fine dust
- code. 5.212.0093 Nylon filter
- code. 5.212.0021 Washable filter
- code. 5.212.0034 HEPA filter











Watch the video on youtube:
www.youtube.com/fasavideo

Wet & dry vacuum cleaners

Titano 78 PL-BS



Standard equipment:

5.209.0021	
6.205.0126	
3.754.0049	
3.754.0048	
3.754.0083	 400 mm
3.754.0084	
3.754.0085	
5.509.0039	

Equipped with:

- 3 Silenced two stage Motor
- Professional closing hooks
- Suction system with by-pass cooling
- Plastic tank (PP)
- Tilting tank
- Fully removable tank
- Liquid float valve
- 10 mt power cable
- Cable holder
- Ergonomic handle tank, head and trolley
- Easy standing head (during filter cleaning)

Titano 78 PL-BS

Code	8.212.0509
N°motors - power (max)	3 - 3000 (3600) W
Column depress.	22,4 kPa/2240 mm H ₂ O
Tank capacity	78 l.
Suction air	162 l/s
Voltage	220V-240V ~ 50-60Hz

Optional:

- code. 5.212.0022 Paper collector filter set
- code. 5.509.1405 Cloth filter for fine dust
- code. 5.212.0093 Nylon filter
- code. 5.212.0021 Washable filter
- code. 5.212.0034 HEPA filter











Watch the video on youtube:
www.youtube.com/fasavideo

Wet & dry vacuum cleaners

Titano 78 Inox BS



Standard equipment:

5.209.0021	
6.205.0126	
3.754.0049	
3.754.0048	
3.754.0083	 400 mm
3.754.0084	
3.754.0085	
5.509.0039	

Equipped with:

- 3 Silenced two stage Motor
- Professional closing hooks
- Suction system with by-pass cooling
- S/S tank
- Tilting tank
- Fully removable tank
- Plastic handle
- Liquid float valve
- Power cable 10 mt
- Cable holder
- Ergonomic handle tank, head and trolley
- Shock proof trolley
- Easy standing head (during filter cleaning)
- Static electric shock inhibitor

Titano 78 Inox BS

Code	8.212.0502
N°motors - power (max)	3 - 3000 (3600) W
Column depress.	22,4 kPa/2240 mm H ₂ O
Tank capacity	78 l.
Suction air	162 l/s
Voltage	220V-240V ~ 50-60Hz

Optional:

- code. 5.212.0022 Paper collector filter set
- code. 5.509.1405 Cloth filter for fine dust
- code. 5.212.0093 Nylon filter
- code. 5.212.0021 Washable filter
- code. 5.212.0034 HEPA filter



Watch the video on youtube:
www.youtube.com/fasavideo

Wet & dry vacuum cleaners

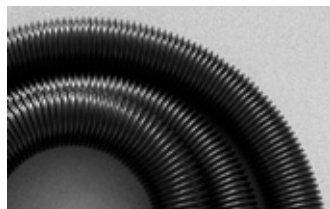

Flexible hose Ø 35

Code	Description	m	Ø
3.753.0063	Roll of flexible hose without swivel	30	35



Code	Description	Ø
3.752.0118	Sleeve tank side	35



3.752.0028	Swivel straight accessories side	35
------------	----------------------------------	----



3.753.0077	Swivel curved accessories side	35
------------	--------------------------------	----

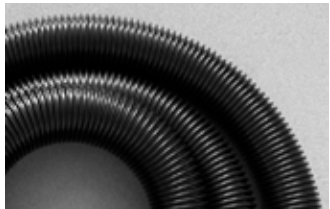

Flexible hose Ø 40

Code	Description	m	Ø
3.753.0038	Roll of flexible hose without swivel	30	40



Code	Description	Ø
3.754.0047	Sleeve tank side	40



3.754.0046	Swivel straight accessories side	40
------------	----------------------------------	----

Complete flexible hose Ø 40



Code	Description	m	Ø
5.209.0127	Flexible hose with swivel	4	40
5.209.0082	Flexible hose with swivel	5	40
6.205.0130	Flexible hose with swivel for Injection extraction	5	40
6.205.0131	Flexible hose with swivel for Injection extraction	10	40

Wet & dry vacuum cleaners



Ø 40 Spacer for plastic bag 58 l. (only for Domino 78 Inox/Domino 78 Inox BS/ Titano 78 PL-BS/Titano 78 Inox BS/Windy 278 IF/Windy 378 IR models)
This accessory is necessary when using collector bag: the use of collector bag is not possible without PVC spacer.
The use of the collector bag grants easy filter cleaning and its quick replacement whenever necessary, saving time also during the operation of tank cleaning.

PVC spacer

Code 0.110.0021



Ø 40 Gangway tool (only for Domino 78 Inox BS/Titano 78 PL-BS/Titano 78 Inox BS/ Windy 378 IR models)

A set made of special accessory with front and back squeegee + a flex connection hose in order to vacuum easily and quickly water and liquid from the floor.

0.911.0210 front squeegee strip with hole
0.911.0211 rear squeegee strip without hole

Gangway tool (only for liquid suction)

Code 0.110.0062



Turbo brush Ø 35

Code 3.754.0081

Ø 35 - 270 mm Turbo brush (Only for: Echo, Windy 120 IF et Windy 130 IF models)

This special brush grants top results, because it has an additional small rotary brush creating a sweeping effect that helps effective suction.



Antifoam device

Code 0.110.0020

This device avoids the forming of foam that may affect the operation of the float.



PROFESSIONAL LINE

Floor scrubber-driers

Direct experience of professional people has resulted in FA-SA floor scrubbers range: easy to handle, powerful, efficient, carefully conceived and designed by using top-quality materials.

Versatility and wide range allow to select the most suitable machine for any work place as well as to maximize performances while reducing time and labour to a minimum.

All products are fully environmentfriendly and aimed to the highest comfort of the user, who will achieve the best results in cleaning even in the hardest conditions of usage.

Floor scrubber driers

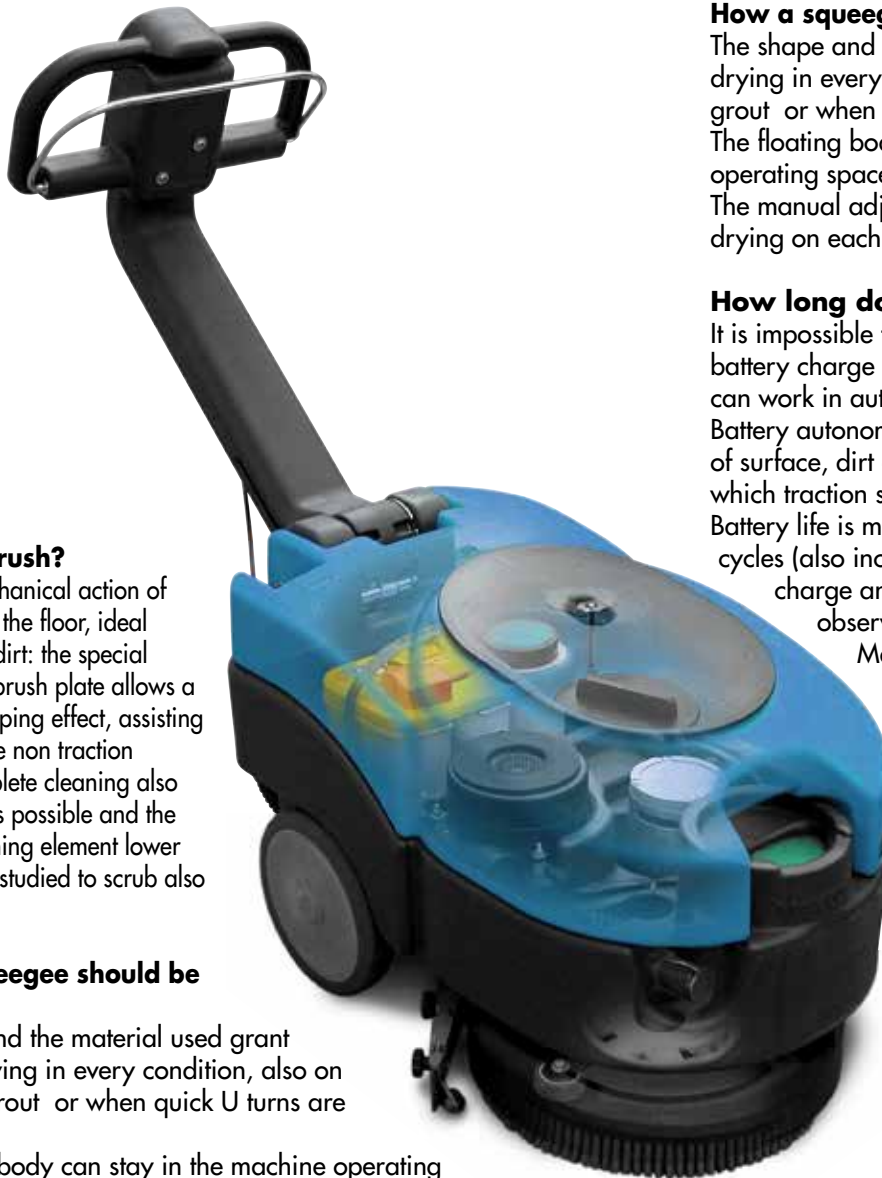

Why disc brush?

Extended mechanical action of the bristles on the floor, ideal for persistent dirt: the special setting of the brush plate allows a balanced gripping effect, assisting easy use in the non traction models. Complete cleaning also next to walls is possible and the compact washing element lower at the sides is studied to scrub also under edges.

How a squeegee should be designed?

The shape and the material used grant a perfect drying in every condition, also on floors with grout or when quick U turns are necessary. The floating body can stay in the machine operating space (compact/room saving) The manual adjusting system grants a perfect drying on each kind of floors.

How long do battery charges last?

It is impossible to determine exactly how long a battery charge lasts and so how long a machine can work in autonomy. Battery autonomy changes depending on type of surface, dirt quantity, brush type and way in which traction system is used (speed and slope). Battery life is made up of number of charge cycles (also incomplete), if use conditions, charge and service are perfectly observed. Manufacturing technology diversifies numbers of cycles, service needed, use/charge conditions and performances.

How a squeegee should be designed?

The shape and the material used grant a perfect drying in every condition, also on floors with grout or when quick U turns are necessary. The floating body can stay in the machine operating space (compact/room saving) The manual adjusting system grants a perfect drying on each kind of floors.

How long do battery charges last?

It is impossible to determine exactly how long a battery charge lasts and so how long a machine can work in autonomy. Battery autonomy changes depending on type of surface, dirt quantity, brush type and way in which traction system is used (speed and slope). Battery life is made up of number of charge cycles (also incomplete), if use conditions, charge and service are perfectly observed.

Manufacturing technology diversifies numbers of cycles, service needed, use/charge conditions and performances.

Applications pads

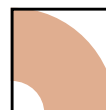

BEIGE PAD - POLISHING - Polyester
To polish all kinds of floor. Use dry.



GREEN PAD - INTERMEDIATE CLEANING ACTION - Nylon To remove all the old superficial wax, rests, obtaining ready floors to be recoated. Use wet.



BLACK PAD - WET STRIPPING - Nylon For wet stripping of heavy layers of wax. Ideal to remove old floor finish scu and cement marks.

Walk-behind floor scrubber driers

A1 36



Standard equipment



- 5.511.1346
PPL brush Ø 360 mm - 15"



- 4.508.1100
Front squeegee blade
L.537 mm - Th. 2.5 mm
- 4.508.1101
Rear squeegee blade
L.590 mm - Th. 3 mm



- 0.108.0061
On-board Battery charger
12V 8A
- only for model code:
8.518.0007



- 0.107.0061
Maintenance free battery
12V 55Ah BT DC 4.2
- only for model code:
8.518.0007



Watch the video on youtube:
www.youtube.com/fasavideo

A1 36

- Suitable to work in high congested areas like small shops, offices, kitchens, schools, hospitals, bars, gyms, restaurants
- Adjustable flow (automatic start-stop with solenoid valve) of the detergent solution depending on type of surface
- Brush with quick release
- Removable recovery tank
- Available in battery version (36B) with integrated battery charger with data memory and for any type of batteries
- Battery included
- Squeegee lifting lever
- Compact reclining handle with control switches
- Easy access and simple service of the components.

	A1 36 E	A1 36 B
Code	8.518.0008	8.518.0007
Power supply	230 V~50 Hz	1 x 12 V
Equipped with	-	Batteries/batt. charger
Scrubbing width	360 mm	360 mm
Squeegee width	460 mm	460 mm
Max working capacity	1260 m ² /h	1260 m ² /h
Detergent tank capacity	11 l.	11 l.
Recovery tank capacity	12/13 l.	12/13 l.
Traction type	mechanical	mechanical
Brush/Vacuum motor power	370/400 W	250/180 W

Walk-behind floor scrubber driers



The unit can be supplied mains (15 m cable available) or battery powered. Reclining handle: fit on any operator's height and allowing the perfect cleaning also on 90° corners. Shock-absorbing covers, simple cleaning of the recovery tank, non

marking wheels. Easy access to mechanical parts (easy maintenance of each component), removable recovery tank without tools.



User friendly analogic control panel. Control lever for brush operation and detergent water outflow. General ON/OFF switch, brush and vacuum motor switch, solenoid valve operation switch.

Parabolic squeegee, easy rubber blades replacement. The floating brush plate and squeegee grant the right cleaning pressure on any type of floor.



Optional accessories:



- 0.107.0050 Battery AGM 12V 55Ah C5



- 0.108.0051 Booster battery charger



- 4.508.1058 Polyurethane front blade L.537 TH. 2,5
- 4.508.1059 Polyurethane rear blade L.590 TH. 3



- 5.511.1413 Tynex brush Ø 360 mm-14"
- 5.511.1411 PPL 0,03 brush Ø 360 mm-14"
- 5.511.1412 PES brush Ø 360 mm-14"



- 5.511.1129 EWU pad driver Ø 360mm-14"



- 6.508.0143 Abrasive pad Ø 381 mm-15" - beige (5 pcs.)
- 6.508.0144 Abrasive pad Ø 381 mm-15" - green (5 pcs.)
- 6.508.0141 Abrasive pad Ø 381 mm-15" - black (5 pcs.)



- 4.512.0068 Extension electric cord 15 m with Schuko plug

Walk-behind floor scrubber driers

A3 45



Standard equipment



- 5.511.1688
PPL brush Ø 430 mm - 17"



- 4.508.X468
Front squeegee blade L.830 mm Shore 40 Th. 2.5 mm
- 4.508.X467
Rear squeegee blade L.870 mm Shore 40 Th. 3 mm



- 0.108.0042
On-board Battery charger
CBHD1 24V 10A
- only for model code:
8.524.1003
8.524.0003



- 2 x 0.107.0061
Maintenance free battery
12 MFP 50 - 12V 50Ah
- only for model code:
8.524.0003

Other available versions:

- 8.524.1003 - A3 45 B without batteries



Watch the video on youtube:
www.youtube.com/fasavideo

	A3 45 E	A3 45 B
Code	8.524.3303	8.524.0003
Power supply	230V~50Hz	24V DC
Equipped with	-	Batteries/batt. charger
Scrubbing width	450 mm	450 mm
Squeegee width	800 mm	800 mm
Max working capacity	1575 m ² /h	1575 m ² /h
Detergent tank capacity	25 l.	25 l.
Recovery tank capacity	25-28 l.	25-28 l.
Traction type	mechanical	mechanical
Brush/Vacuum motor power	550/400 W	450/370 W

A3 45

- Suitable to work in high congested areas like wellness centres and medical environments in general, gyms, retail outlets, car shops, sales points and health care
- Solution water filter and solenoid valve (battery model only)
- User friendly control panel
- Hour meter (optional)
- Chemical dosing system on request
- Recovery water tank with visual inspection
- Reclining handle with control lever (battery model only)
- Low noise operation thanks to the protected positioning of vacuum motor
- Recovery tank drain hose with adjustable flow system
- Indicator of the solution water tank fill level
- Easy access to the recovery tank
- Non-marking wheels.

Walk-behind floor scrubber driers



User friendly analogic control panel. Control lever for brush operation and detergent water outflow. ON/OFF and battery cutout key switch, brush and vacuum motor switch, detergent dosing knob (optional), Thermal circuit breaker to protect

vacuum and brush motor, battery level indicator, hour meter (optional). Automatic detergent dosing system on request. Indicator of clean water tank level. Detergent solution regulation. Recovery tank drain hose with adjustable



flow system. Easy access to recovery water tank with visual inspection. Extremely silent (62 dB) thanks to the particular housing of the vacuum motor and the use of soundproofing material.



Thanks to the special squeegee support it is easily possible the tilting of the machine to carry out the drying of the floor without scrubbing. The oversize wheels facilitate maneuverability and effortless use.



Optional accessories:



- 0.107.0050 Battery AGM 12V 55Ah C5



- 4.508.1178 Polyurethane front blade L.830 TH. 3
- 4.508.1177 Polyurethane rear blade L.870 TH. 4



- 5.511.1713 Tynex brush Ø 430 mm-17"
- 5.511.1711 PPL 0,03 brush Ø 430 mm-17"
- 5.511.1712 PES brush Ø 430 mm - 17"

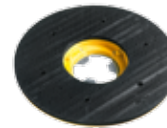

- 5.511.1095 EWU pad driver Ø 430 mm-17"



- 6.508.0032 Abrasive pad Ø 430 mm-17" - beige (5 pcs.)
- 6.508.0039 Abrasive pad Ø 430 mm-17" - green (5 pcs.)
- 6.508.0046 Abrasive pad Ø 430 mm-17" - black (5 pcs.)



- 4.512.0068 Extension electric cord 15 m with Schuko plug

- 5.511.1687 Automatic detergent dosing system on request.

Walk-behind floor scrubber driers

A4 45

NEW



Standard equipment



- 5.511.1941
Brosse PPL Ø 430 mm - 17"



- 4.508.1319 Front squeegee blade Shore 40 Th.
- 4.508.1320 Rear squeegee blade Shore 40 Th.



- 0.108.0073
On-board Battery charger
24V 10A

(only for model code:
8.580.0005/8.580.0006)



- 2 x 0.107.0061
Maintenance free battery
12 MFP 50 - 12V 50Ah

only for model code:
8.580.0006



Watch the video on youtube:
www.youtube.com/fasavideo

	A4 45E	A4 45 B	A3 45 B
Code	8.580.0004	8.580.0005	8.580.0006
Power supply	230V~50Hz	24V DC	24V DC
Equipped with	-	Batt. charger	Batteries/batt. charger
Scrubbing width	450 mm	450 mm	450 mm
Squeegee width	540 mm	540 mm	540 mm
Max working capacity	1575 m2/h	1575 m2/h	1575 m2/h
Detergent tank capacity	30 l.	30 l.	30 l.
Recovery tank capacity	32-35 l.	32-35 l.	32-35 l.
Traction type	mechanical	mechanical	mechanical
Brush/Vacuum motor power	400/400 W	400/400 W	400/400 W

A4 45

- Ideal for small and medium floors up to 1600sqm, especially when congested by people or furnishing like in wellness centres, gyms, car showroom, retail shops, hospitals and schools.
- Automatic brush attachment, discharge and delayed cut-off.
- Adjustable solution release with automatic cut-off.
- Narrow body with both side brush protrusion and 300° squeegee spin.
- Tool less removable recovery tank with large visual inspection window and stretchable discharge hose.
- Adjustable driving handle with dead man switches, soft touch controls and diagnosis (Eco Energy mode and battery low level automatic cut-off for DC version).
- Large non marking working wheels and sturdy rear roller for displacements.

Walk-behind floor scrubber driers



Protection against overloads, battery discharge abuse (DC only) and undesired run. Convenient one switch maintenance over the brush. Eco Energy setting for extensive working time and extremely quiet operations (DC only). Accessible on-

board charger (DC only, when provided), far away from sprays. Time saving convenient foot operating squeegee lift. Handle can be easily adjusted to fit comfort of operators even in narrow spaces. Easy access and handling to clean recovery tank and



floaters. Less downtimes due to simple maintenance and construction. Great visibility and cleaning capability on hard to reach edges on both sides of the brush. Extensive squeegee spin for easy blade replacement and perfect suction even on corners

Easy setting and automatic solution release to save chemical and fit different floor conditions. High stability and capability to overtake small steps.



Optional accessories:



- 0.107.0050 Battery AGM 12V 55Ah



- 4.508.1324 Polyurethane front blade TH. 3
- 4.508.1325 Polyurethane rear blade TH. 4



- 5.511.1942 Tynex brush Ø 430 mm-17"
- 5.511.1943 PP 0,03 brush Ø 430 mm-17"
- 5.511.1944 PES brush Ø 430 mm - 17"

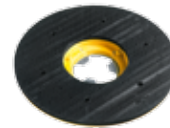

- 5.511.0229 EWU pad driver Ø 430 mm-17"



- 6.508.0032 Abrasive pad Ø 430 mm-17" - beige (5 pcs.)
- 6.508.0039 Abrasive pad Ø 430 mm-17" - green (5 pcs.)
- 6.508.0046 Abrasive pad Ø 430 mm-17" - black (5 pcs.)



- 4.512.0068 Extension electric cord 15 m with Schuko plug

Walk-behind floor scrubber driers

A5 EVO 50



Standard equipment



- 5.511.1097
PPL brush Ø 483 mm - 19"



- 4.508.X468
Front squeegee blade L.830 mm Shore 40 Th. 2.5 mm
- 4.508.X467
Rear squeegee blade L.870 mm Shore 40 Th. 3 mm



- 0.108.0042
On-board Battery charger
CBHD1 24V 10A
only for model code:
8.527.0007 - 8.527.0008
8.527.0013 - 8.527.0046



- 0.107.0054
Maintenance free battery
12V 75Ah BT DC 5.5
only for model code:
8.527.0013 - 8.527.0046

Other available versions:

- 8.527.0007- A5 Evo 50 B with battery charger
- 8.527.0013 - A5 Evo 50 B with batteries and battery charger
- 8.527.0046 - A5 Evo 50 BT with batteries and battery charger



Watch the video on youtube:
www.youtube.com/fasavideo

A5 EVO 50

- Very compact scrubbing machines suitable to work for the maintenance cleaning of limited-size areas (up to 1.500 m²)
- Especially suitable for cleaning: car shops, sales points, gym, health care
- Control panel with operator presence safety system
- Low level battery indicator: brush/vacuum and traction progressive cut off
- Solution water filter and solenoid valve (battery model only)
- Easy access to the battery compartment
- Quick drain and easily inspectable recovery tank
- Non-marking wheels
- Roto-molded polyethylene tanks, shock and acid resistant
- The lower tank also serves as battery compartment
- Low noise operation thanks to the protected positioning of vacuum motor.

	A5 EVO 50 E	A5 EVO 50 B	A5 EVO 50 BT
Code	8.527.0005	8.527.0006	8.527.0008
Power supply	230V~50Hz	24V DC	24V DC
Equipped with	-	-	Batt. charger
Scrubbing width	500 mm	500 mm	500 mm
Squeegee width	800 mm	800 mm	800 mm
Max working capacity	2000 m ² /h	2000 m ² /h	2000 m ² /h
Detergent tank capacity	44 l.	44 l.	44 l.
Recovery tank capacity	50/60 l.	50/60 l.	50/60 l.
Traction type	mechanical	mechanical	automatic
Brush/Vacuum motor power	550/1000 W	550/400 W	550/400 W

Walk-behind floor scrubber driers



Powerful gearmotor; metal brush plate with integrated plastic splash guard/ bumper.

The outflow of the detergent solution is controlled by a solenoid valve. The actuation of the solenoid valve is operated by the control lever, avoiding the detergent solution outflow when the brush is stopped during the interruptions of work.



Renovated squeegee with new pressure adjusting system. The squeegee blades are easily replaceable without the use of tools. Quick and easy squeegee coupling through the two large knobs; the squeegee is released without any damage in the

event of accidental impact. Easy and intuitive controls. The outflow of the cleaning solution is easily controlled using the mechanical lever placed on the control panel. Inspectable mesh filter to trap any existing solid body in the cleaning solution.



Optional accessories:



- 2 x 0.107.0002
Tubular battery Pb-acid
12V 118Ah C5



- 2 x 0.107.0063
GEL Battery 12 MFP 105
12V 105Ah C5



- 4.508.1178 Polyurethane
front blade L.830 TH. 3
- 4.508.1177 Polyurethane
rear blade L.870 TH. 4



- 5.511.1098
Tynex brush Ø 483 mm-19"
- 5.511.1128
PPL 0,03 brush Ø 483 mm-19"
- 5.511.1206
PES brush Ø 483 mm - 19"



- 5.511.1099
EWU pad driver Ø 483
mm-19"



- 6.508.0034
Abrasive pad Ø 483 mm-19"
- beige (5 pcs.)
- 6.508.0041
Abrasive pad Ø 483 mm-19"
- green (5 pcs.)
- 6.508.0048
Abrasive pad Ø 483 mm-19"
- black (5 pcs.)



- 4.512.0068
Extension electric cord 15 m
with Schuko plug

Walk-behind floor scrubber driers

A8 EVO 66



Standard equipment



- 2 x 5.511.1105
PPL brush Ø 330 mm - 13"



- 4.508.1524
Front squeegee blade L.860 mm
Shore 33 Th. 4 mm
- 4.508.1523
Rear squeegee blade L.900 mm
Shore 40 Th. 4 mm



- 0.108.0059
On-board Battery charger
CBHD1-XR 24V 12A



Watch the video on youtube:
www.youtube.com/fasavideo



	A8 EVO 66 BTA
Code	8.525.1303
Power supply	24V DC
Equipped with	Batt. charger
Scrubbing width	660 mm
Squeegee width	800 mm
Max working capacity	2640 m ² /h
Detergent tank capacity	55 l.
Recovery tank capacity	55/65 l.
Traction type	200W/automatic
Brush/Vacuum motor power	2x400/400 W

A8 Evo 66

- Designed for the maintenance and deep cleaning of large areas (up to 1.700 m²)
- Especially suitable for cleaning: car shops, sales points, gym, health care
- User friendly control panel
- Automatic brush lifting
- Fully accessible recovery water tank with visual inspection
- Automatic detergent measuring system
- Big size traction wheels
- Handle with control lever

Walk-behind floor scrubber driers



User friendly analogic control panel. Control lever for brush operation and detergent water outflow. ON/OFF and battery cutout key switch, brush and vacuum motor switch, detergent regulation device (optional). Thermal circuit breaker to protect

vacuummotor and brush motor, battery charge level indicator, hour meter. Clean water tank level indicator. Detergent regulation device. Recovery tank drain hose with adjustable flow system. Automatic brush lifting



Automatic detergent dosing system (only model 66TA). Fully accessible recovery water tank with visual inspection. Easy access to the recovery tank. Easy access and simple service of the components without use of tools.

Battery trolley for a quick and easy battery change. Big size wheels for better maneuverability and effortless use.



Optional accessories:



- 2 x 0.107.0002
Tubular battery Pb-acid
12V 118Ah C5



- 2 x 0.107.0063
GEL Battery 12 MFP 105
12V 105Ah C5



- 0.108.0001
Battery Charger 24V 12A
220-240/50-60



- 5.511.1494
On-board Battery charger
kit - 24V - 12A



- 4.508.1526 Polyurethane
front blade L.860 TH. 4
- 4.508.1525 Polyurethane
rear blade L.900 TH. 4



- 2 x 5.511.1106
Tynex brush Ø 330 mm-13"
- 2 x 5.511.1255
PPL 0,03 brush Ø 330 mm-13"
- 2 x 5.511.1202
PES brush Ø 330 mm-13"



- 2 x 5.511.1107
EWU pad driver Ø 330mm-13"



- 6.508.0030 - Ø 340 mm-
13"- beige (5 pcs.)
- 6.508.0037 - Ø 340 mm-
13"- green (5 pcs.)
- 6.508.0044 - Ø 340 mm-
13"- black (5 pcs.)

Walk-behind floor scrubber driers

A9



Standard equipment



A9 50T

- 5.511.1097
PPL brush Ø 483 mm - 19"



A9 55T

- 2 x 5.511.1101
PPL brush Ø 275 mm - 10"



A9 66T

- 2 x 5.511.1105
PPL brush Ø 330 mm - 13"



- 4.508.X468
Front squeegee blade L.830 mm
Shore 40 Th. 2.5 mm
- 4.508.X467
Rear squeegee blade L.870 mm
Shore 40 Th. 3 mm



Watch the video on youtube:
www.youtube.com/fasavideo

A9

- Suitable to work for the maintenance and deep cleaning of large areas (up to 2.200 m²)
- User friendly control panel: forward speed setting, scrubbing and vacuuming selectors, battery charge indicator, traction direction indicator, key main switch
- Large handle with traction driving lever for forward and backward directions
- Self levelling brush plate
- Cover removable without tools provided with self locking system
- Quick vacuum motor and filter inspection, without tools
- Detergent solution tank with large opening protected by quick locking cap
- Parking brake directly on the wheel
- Non-marking wheels
- Easy squeegee regulation without tools
- Movable shock-proof squeegee
- Hour meter and solenoid valve.

	A9 50 BT	A9 55 BT	A9 66 BT
Code	8.516.0413	8.516.0414	8.516.0424
Power supply	24V DC	24V DC	24V DC
Equipped with	-	-	-
Scrubbing width	500 mm	550 mm	660 mm
Squeegee width	800 mm	800 mm	800 mm
Max working capacity	2250 m ² /h	2475 m ² /h	2970 m ² /h
Detergent tank capacity	67 l.	67 l.	67 l.
Recovery tank capacity	77/95 l.	77/95 l.	77/95 l.
Traction type	200W/automatic	200W/automatic	200W/automatic
Brush/Vacuum motor power	600/450 W	600/450 W	600/450 W

Walk-behind floor scrubber driers



User friendly control panel. Speed adjustment selectors. General ON/OFF and key switch, brush and vacuum motor switch. Thermal circuit breaker to protect vacuum motor and brush motor, battery level control, hour meter.

Easy access to battery and vacuum motor compartment, without using tools. Large tank capacity, at the top in the category (67 l). 2 x 12V -118 Ah C5 batteries to grant long work autonomy, up to 3 hours.



Control lever for brush operation and detergent water outflow. Recovery tank drain hose. Quick fitting battery charger plug.

Heavy duty 15 mm steel monobloc brush plate. Great pressure on the floor for a deep cleaning even on the toughest dirt. Self levelling system. Solenoid valve to stop the detergent water outflow during the work interruptions.



Optional accessories:



- 2 x 0.107.0002
Tubular battery Pb-acid
12V 118Ah C5



- 2 x 0.107.0063
GEL Battery 12 MFP 105
12V 105Ah C5



- 0.108.0001
Battery Charger 24V 25A
220-240/50-60



- 5.511.1494
On-board Battery charger
kit - 24V - 12A



- 4.508.1178 Polyurethane
front blade L.830 TH. 3
- 4.508.1177 Polyurethane
rear blade L.870 TH. 4



- 5.511.1098
Tynex brush Ø 483 mm-19"
- 2 x 5.511.1102
Tynex brush Ø 275 mm-10"
- 2 x 5.511.1106
Tynex brush Ø 330 mm-13"

- 5.511.1128
PPL 0,03 brush Ø 483 mm-19"
- 2 x 5.511.1254
PPL 0,03 brush Ø 275 mm-10"
- 2 x 5.511.1255
PPL 0,03 brush Ø 330 mm-13"

- 5.511.1206
PES brush Ø 483 mm - 19"
- 2 x 5.511.1201
PES brush Ø 275 mm-10"
- 2 x 5.511.1202
PES brush Ø 330 mm-13"



- 5.511.1099
EWU pad driver Ø 483mm-19"
- 2 x 5.511.1103
EWU pad driver Ø 275mm-10"
- 2 x 5.511.1107
EWU pad driver Ø 330mm-13"



- (5 pcs package)
- 6.508.0034 - Ø 483 mm-19"- beige
 - 6.508.0041 - Ø 483 mm-19"- green
 - 6.508.0048 - Ø 483 mm-19"- black
 - 6.508.0095 - Ø 280 mm-11"- beige
 - 6.508.0096 - Ø 280 mm-11"- green
 - 6.508.0097 - Ø 280 mm-11"- black
 - 6.508.0030 - Ø 340 mm-13"- beige
 - 6.508.0037 - Ø 340 mm-13"- green
 - 6.508.0044 - Ø 340 mm-13"- black

Walk-behind floor scrubber driers

A12 75



Standard equipment

A12 75T



- 2 x 5.511.1168
PPL brush Ø 360 mm - 14"



- 4.508.0646
Front squeegee blade L.925 mm
Shore 40 Th. 3 mm
- 4.508.0605
Rear squeegee blade L.1015 mm
Shore 30 Th. 4 mm



Watch the video on youtube:
www.youtube.com/fasavideo

A12 75 BT

Code	8.517.0106
Power supply	24V DC
Equipped with	-
Scrubbing width	750 mm
Squeegee width	900 mm
Max working capacity	4275 m ² /h
Detergent tank capacity	88 l.
Recovery tank capacity	91/95 l.
Traction type	300W/automatic
Brush/Vacuum motor power	1000/550 W

A12

- Capable to work for the maintenance and deep cleaning of large areas (up to 2.600 m²)
- User friendly control panel: forward speed setting, scrubbing and vacuuming selectors, battery charge indicator, traction direction indicator, key main switch
- Large handle with traction driving lever for forward and backward directions
- Self levelling brush plate
- Cover removable without tools
- Quick vacuum motor and filter inspection, without tools
- Detergent solution filter
- Detergent solution tank provided with large opening protected by quick locking cap.

Walk-behind floor scrubber driers



Easy access to battery and vacuum motor compartment, without using tools. Large capacity shock and acid proof polyethylene tanks (88 l) avoid frequent refilling and idle time. 4 x 6V -180 Ah C5 batteries

granting continuous working time up to 4-5 hours. Adjustable speed ensures high precision in cleaning congested areas with obstacles. Intuitive controls reduce operator's training time. Safety thermal breakers prevent motor problems



in case of overheating or operator's misuse. Heavy duty V-shaped squeegee ensures perfect drying of every type of floor, even with large joints. Non-marking wheels avoid marks after the drying. Completely adjustable to fit any surface.



Strong mechanical control levers for heavy duty use. Large size drain hose for a fast emptying and a better cleaning of the recovery tank. Quick fitting battery charger plug.



Optional accessories:



- 4 x 0.107.0004
Tubular battery Pb-acid
6V 180Ah C5



- 4 x 0.107.0072
GEL Battery 6 MFP 180
6V 180Ah C5



- 0.108.0002
Battery Charger 24V 25A
220-240/50-60
- 5.511.1495
On-board Battery charger
kit - 24V - 25A



- 4.508.0901 Polyurethane
front blade L.925 TH.3 Sh.40
- 4.508.0900 Polyurethane
rear blade L.1015 TH.4 Sh.40



- 2 x 5.511.1246
Tynex brush Ø 360 mm-14"
- 2 x 5.511.1169
PPL 0,03 brush Ø 360 mm-14"
- 2 x 5.511.1203
PES brush Ø 360 mm - 14"



- 2 x 5.511.1129
EWU pad driver Ø 360 mm-14"



(5 pcs package)

- 6.508.0030 - Ø 340 mm-13"- beige
- 6.508.0037 - Ø 340 mm-13"- green
- 6.508.0044 - Ø 340 mm-13"- black
- 6.508.0143 - Ø 380 mm-15"- beige
- 6.508.0144 - Ø 380 mm-15"- green
- 6.508.0141 - Ø 380 mm-15"- black

Ride-on floor scrubber driers

A12 Rider



Standard equipment



- 2 x 5.511.1789
PPL Brush Ø 330 mm - 13"



- 4.508.1619
Front squeegee blade L.960 mm
Th 2,5 mm
- 4.508.1618 Rear squeegee
blade L.1000 mm Th. 3 mm



- 0.108.0054
On-board Battery charger
CBH2D 24V 20A
(only for model code:
8.579.0004)



- 2 x 0.107.0063
Gel battery 12V 105 A/C
5/120A C20
(only for model code:
8.579.0004)



Watch the video on youtube:
www.youtube.com/fasavideo

A12 Rider

Designed for the maintenance and deep cleaning of large areas (up to 3200 sqm.) with a very important reduction of cleaning cost. Very compact size and great maneuverability like walk behind models: suited for maintenance cleaning. • 32 kg. of constant pressure on the brushes. • Double counter rotating brush (66 cm of scrubbing width) obtaining better stability and constant pressure • Great working autonomy (till 4,5 hours) thanks to the possibility to use 4 batteries 6 V 240 Ah and to rear wheel-drive • Large load tank capacity (real load of 75 l.), resulting in reduced numbers of stops and maximum use of battery for effective operation of the machine • Ergonomic steering wheel of new design with user friendly controls and digital display • Easy access to electrical components • Inspection cover for fast and easy cleaning and sanification of dirt water tank • Automatic device that stops brushes and detergent water outflow when the machine is stationary • Self-levelling brush plate • Automatic detergent measuring system on request.

	A12 Rider	A12 Rider
Code	8.579.0003	8.579.0004
Power supply	24V DC	24V DC
Equipped with	-	Batteries/batt. charger
Scrubbing width	660 mm	660 mm
Squeegee width	855 mm	855 mm
Max working capacity	3250 m2/h	3250 m2/h
Detergent tank capacity	80 l.	80 l.
Recovery tank capacity	80-85 l.	80-85 l.
Traction type	400W/rear wheel-drive	400W/rear wheel-drive
Brush/Vacuum motor power	2x400W/400 W	2x400W/400 W

Ride-on floor scrubber driers



Great working autonomy thanks to the possibility to use 4 batteries 6 V 240 Ah granting continuous working. Possibility to use also 2 batteries 12V. Less battery consumption thanks to rear wheel-drive. Large load tanks made of shock and acid proof polyethylene (real load of 75 l.), avoiding frequent stop for refilling.

User friendly control panel. Steering wheel with digital controls and display. Squeegee and brush plate mechanical and user friendly lifting lever: min. maintenance cost training time for the users. Scrubbing unit with double brush with brush plate made of steel for a great pressure (32 Kg.) on the floor resulting in an easy and deep cleaning of any kind of dirt.



Rear wheel-drive on 2 wheels allows the machine to get over remarkable slopes. Detergent solution is cleansed by an external completely accessible filter, that holds any impurities, thus protecting the solenoid valve. The easy access to all internal components of A12 Rider make it possible to reduce maintenance cost.

The comfortable and ergonomic seat allows the operator to work effortless for a long time, improving productivity. Its very compact size make it perfect to work in small areas where walk behind models are usually used. The use of A12 Rider makes working easier and quicker with a huge saving of time.



Optional accessories:



- 4 x 0.107.0004
Tubular battery Pb-acid
6V 180Ah C5



- 4 x 0.107.0072
Gel battery 6 MFP 180
6V 180Ah C5



- 2 x 0.107.0002
Tubular battery Pb-acid
12V 118 Ah C5



- 0.108.0002
Battery charger 24V 25A
220-240/50-60



- 4.508.1594 Polyurethane
front blade L.960 TH.3 Sh.40
- 4.508.1596 Polyurethane
rear blade L.1000 TH.4
Sh.40



- 2 x 5.511.1106
Tynex brush Ø 330 mm-13"
- 2 x 5.511.1255
PPL 0,03 brush Ø 330 mm-13"
- 2 x 5.511.1202
PES brush Ø 330 mm - 13"



- 2 x 5.511.1107
EWU pad driver
Ø 330 mm-13"



- 2 x 6.508.0030 - Ø 340
mm - 13"- beige (5 pcs.)
- 2 x 6.508.0037 - Ø 340
mm - 13"- green (5 pcs.)
- 2 x 6.508.0044 - Ø 340
mm - 13"- black (5 pcs.)



- 6.505.0062
Flashing beacon

Ride-on floor scrubber driers

A13 R Essential



Standard equipment



A13 R 75

- 2 x 5.511.1168
PPL brush Ø 360 mm - 14"



A13 R 85

- 2 x 5.511.1688
PPL brush Ø 430 mm - 17"



A13 R 75

- 4.508.0646
Front squeegee blade L.925 mm
Shore 40 Th. 3 mm
- 4.508.0605
Rear squeegee blade L.1015 mm
Shore 30 Th. 4 mm

A13 R 85

- 4.508.1196
Front squeegee blade L.1027 mm
Shore 40 Th. 3 mm
- 4.508.1195
Rear squeegee blade L.1150 mm
Shore 33 Th. 4 mm



Watch the video on youtube:
www.youtube.com/fasavideo

A13 R Essential

- Capable to work for the maintenance and deep cleaning of large areas (up to 3.700 m²) with a very important reduction of cost of cleaning
- More than 50 kg of constant pressure on the brushes
- Large load tank capacity, resulting in reduced number of stops and maximum use of battery charge for effective operation of the machine
- Compact size (810 mm)
- Stability even when fully loaded, front independent wheel drive with tight steering radius
- Recovery tank control window for cleaning and easy ordinary maintenance
- Easy access to electrical components
- Automatic device that stops brushes and detergent water outflow when the machine is stationary
- Self-levelling brushes

	A13 R 75 Essential	A13 R 85 Essential
Code	8.574.4002	8.574.4004
Power supply	24V DC	24V DC
Equipped with	-	-
Scrubbing width	750 mm	850 mm
Squeegee width	900 mm	1000 mm
Max working capacity	3750 m ² /h	4100 m ² /h
Detergent tank capacity	110 l.	110 l.
Recovery tank capacity	130-155 l.	130-155 l.
Traction type	600W/front motorwheel	600W/front motorwheel
Brush/Vacuum motor power	2x400W/400 W	2x400W/400 W

Ride-on floor scrubber driers



The detergent water tank serves as battery compartment, allowing the housing of great capacity batteries granting continuous working time up to 4-5 hours. Large capacity shock and acid proof polyethylene tank (110 l) improves productivity avoiding frequent refilling

and idle time. Simple and intuitive controls reduce operator's training time. Easy mechanical brush plate and squeegee lifting system, for low maintenance costs. The enbloc brush plate apply a very high pressure (50 kg) to the floor, strongly and deeply removing any kind of dirt.



New control panel with digital controls and display. Digital display: with hour meter, battery charge level indicator, empty water tank level indicator and forward/reverse traction indicator. Speed control adjustment, horn, suction motor switch with delayed switch-off, brush plate lifting/lowering

selector switch, brush motor switch. The ergonomic and comfortable shape of the machine allows the operator to work effortless for a long time, improving productivity.



Optional accessories:



- 4 x 0.107.0004 Tubular battery Pb-acid 6V 180Ah C5 + 2 x 5.511.0561 connection cable batteries



- 4 x 0.107.0072 GEL Battery 6 MFP 180 6V 180Ah C5 + 2 x 5.511.0561 connection cable batteries



- 0.108.0002 Battery Charger 24V 25A 220-240/50-60



- 5.511.1641 On-board Battery charger kit - 24V - 20A



- 4.508.0901 Polyurethane front blade L.925 TH.3 Sh.40
- 4.508.0900 Polyurethane rear blade L.1015 TH.4 Sh.40
- 4.508.1251 Polyurethane front blade L.1027 TH.3
- 4.508.1252 Polyurethane rear blade L.1150 TH.4



- 2 x 5.511.1246 Tynex brush Ø 360 mm-14"
- 2 x 5.511.1169 PPL 0,03 brush Ø 360 mm-14"
- 2 x 5.511.1203 PES brush Ø 360 mm - 14"
- 2 x 5.511.1713 Tynex brush Ø 430 mm-17"
- 2 x 5.511.1711 PPL 0,03 brush Ø 430 mm-17"
- 2 x 5.511.1712 PES brush Ø 430 mm - 17"



- 2 x 5.511.1592 EWU pad driver Ø 380 mm-15"
- 2 x 5.511.1095 EWU pad driver Ø 406 mm-17"



- 6.508.0143 - Ø 380 mm - 15"- beige (5 pcs.)
- 6.508.0144 - Ø 380 mm - 15"- green (5 pcs.)
- 6.508.0141 - Ø 380 mm - 15"- black (5 pcs.)
- 6.508.0032 - Ø 406 mm - 17"- beige (5 pcs.)
- 6.508.0039 - Ø 406 mm - 17"- green (5 pcs.)
- 6.508.0046 - Ø 406 mm - 17"- black (5 pcs.)

Ride-on floor scrubber driers

A13 R UP



Standard equipment



A13 R 75 UP
 • 2 x 5.511.1168
 PPL brush Ø 360 mm - 14"



A13 R 85 UP
 • 2 x 5.511.1688
 PPL brush Ø 430 mm - 17"



A13 R 75 UP
 • 4.508.0646
 Front squeegee blade L.925 mm
 Shore 40 Th. 3 mm
 • 4.508.0605
 Rear squeegee blade L.1015 mm
 Shore 30 Th. 4 mm

A13 R 85 UP
 • 4.508.1196
 Front squeegee blade L.1027 mm
 Shore 40 Th. 3 mm
 • 4.508.1195
 Rear squeegee blade L.1150 mm
 Shore 33 Th. 4 mm



• 0.108.0054
 On-board Battery charger
 CBH2D 24V 20A



Watch the video on youtube:
www.youtube.com/fasavideo

A 13 R UP

- Capable to work for the maintenance and deep cleaning of large areas (up to 4.000 m²) with a considerable reduction of cleaning costs
- More than 50 kg of constant pressure on the brushes
- Large load tank capacity, resulting in reduced number of stops and maximum use of battery charge for effective operation of the machine
- Compact size (810 mm)
- Stability even when fully loaded, front independent wheeldrive with tight steering radius
- Recovery tank control window for cleaning and easy ordinary maintenance
- Automatic brush plate lifting system
- Automatic squeegee lifting system
- Automatic squeegee lifting while reverse going
- Automatic device that stops brushes and detergent water outflow when the machine is stationary
- Antifoam device
- Self-levelling brushes
- Integrated on-board battery charger.

	A13 R 75 UP	A13 R 85 UP
Code	8.574.4102	8.574.4104
Power supply	24V DC	24V DC
Equipped with	Batt. charger	Batt. charger
Scrubbing width	750 mm	850 mm
Squeegee width	900 mm	1000 mm
Max working capacity	3750 m ² /h	4100 m ² /h
Detergent tank capacity	110 l.	110 l.
Recovery tank capacity	130-155 l.	130-155 l.
Traction type	600W/front motorwheel	600W/front motorwheel
Brush/Vacuum motor power	2x400W/400 W	2x400W/400 W

Ride-on floor scrubber driers



The easy access to the recovery tank allows fast cleaning and sanitification of the tank; the tilting tank together with a large size drain hose allow the complete emptying of the tank and the removal of any type of solid dirt. The antifoam device protects suction motor, as well as the electronic floating

switch that stops suction when the tank is full. A13 R UP is equipped with actuators for the automatic lifting of the brush plate and squeegee. New control panel with digital controls and display. Digital display: with hour meter, battery charge level indicator, empty water tank level indicator and forward/



reverse traction indicator. Speed control adjustment, horn, suction motor switch with delayed switch-off, brush plate lifting/lowering selector switch, brush motor switch. All motors are protected by thermal breakers. The detergent water tank serves as battery compartment, allowing the housing of great capacity

batteries. Battery charger and suction motor are placed in the recovery tank; the housing of the vacuum motor allows to drastically reduce the operating noise. The ergonomic and comfortable shape of the machine allows the operator to work effortlessly for a long time, improving productivity.



Optional accessories:



- 4 x 0.107.0004 Tubular battery Pb-acid 6V 180Ah C5 + 2 x 5.511.0561 connection cable batteries



- 4 x 0.107.0072 GEL Battery 6 MFP 180 6V 180Ah C5 + 2 x 5.511.0561 connection cable batteries



- 4.508.0901 Polyurethane front blade L.925 TH.3 Sh.40
- 4.508.0900 Polyurethane rear blade L.1015 TH.4 Sh.40
- 4.508.1251 Polyurethane front blade L.1027 TH.3
- 4.508.1252 Polyurethane rear blade L.1150 TH.4



- 2 x 5.511.1246 Tynex brush Ø 360 mm-14"
- 2 x 5.511.1169 PPL 0,03 brush Ø 360 mm-14"
- 2 x 5.511.1203 PES brush Ø 360 mm - 14"
- 2 x 5.511.1713 Tynex brush Ø 430 mm-17"
- 2 x 5.511.1711 PPL 0,03 brush Ø 430 mm-17"
- 2 x 5.511.1712 PES brush Ø 430 mm - 17"



- 2 x 5.511.1592 EWU pad driver Ø 380 mm-15"
- 2 x 5.511.1095 EWU pad driver Ø 406 mm-17"



- 6.508.0143 - Ø 380 mm - 15"- beige (5 pcs.)
- 6.508.0144 - Ø 380 mm - 15"- green (5 pcs.)
- 6.508.0141 - Ø 380 mm - 15"- black (5 pcs.)
- 6.508.0032 - Ø 406 mm - 17"- beige (5 pcs.)
- 6.508.0039 - Ø 406 mm - 17"- green (5 pcs.)
- 6.508.0046 - Ø 406 mm - 17"- black (5 pcs.)

Ride-on floor scrubber driers

A18 R 90



Standard equipment



- 2 x 5.511.1845
PPL brush Ø 457 mm - 18"



- 4.508.1196
Front squeegee blade L.1027 mm
Shore 40 Th. 3 mm
- 4.508.1195
Rear squeegee blade L.1150 mm
Shore 33 Th. 4 mm



Watch the video on youtube:
www.youtube.com/fasavideo

A18 R 90

Code	8.575.0011
Power supply	24V DC
Equipped with	-
Scrubbing width	900 mm
Squeegee width	1000 mm
Max working capacity	6200 m ² /h
Detergent tank capacity	140 l.
Recovery tank capacity	150-180 l.
Traction type	1000W/front motorwheel
Brush/Vacuum motor power	1250W/550 W

A18 R 90

- Suitable for maintenance and deep cleaning of medium and large areas (up to 4.500 m²) with a considerable reduction of cleaning costs
- More than 60/80 kg of constant pressure on the brushes
- Large load tank capacity, resulting in reduced number of stops and maximum use of battery charge for effective operation of the machine
- Compact size
- Stability even when fully loaded
- Front independent wheel-drive with tight steering radius
- Easy access to electrical components
- Automatic brush plate lifting system
- Automatic squeegee lifting system
- Automatic squeegee lifting while reverse going
- Automatic device that stops brushes and detergent water outflow when the machine is stationary
- Antifoam device
- Self-levelling brushes
- High-performance batteries resulting in high-working efficiency.

Ride-on floor scrubber driers



Quick lock recovery tank cap allows for fast and easy cleaning and sanitification of the tank; the tilting tank together with a large size drain hose allow the complete emptying of the tank and the removal of any type of solid dirt. The antifoam device protects suction motor, as well as the

electronic floating switch that stops suction when the tank is full. Comfortable steering wheel. User friendly control panel, provided with hour meter, speed adjustment knob and detergent solution low level warning light. All motors are protected



by thermal breakers. 80 kg of continuous brush plate pressure with Self Leveling System to strongly and deeply removing any kind of dirt on any kind of floor. Strong oil-proof polyurethane wheels. 500 Ah C5 battery box allowing continuous working time

up to 5 hours. Built with strong components, A 18 have been designed to resist even to extreme stresses; the frame is made of steel profiles with a thickness varying from 5 to 12 mm, protected with a high resistance corrosion-proof paint.



Optional accessories:



- 0.107.0008 Battery box Pb-acid 24V 500Ah C5
- 0.107.0011 Gel battery box 24V 400Ah C5



- 0.108.0003 Battery Charger 24/36V 50/60A - 220-240/50-60



- 4.508.1251 Polyurethane front blade L.1027 TH. 3
- 4.508.1252 Polyurethane rear blade L.1150 TH. 4



- 2 x 5.511.1848 Tynex brush Ø 457 mm-18"
- 2 x 5.511.1849 PPL 0,03 brush Ø 457 mm-18"
- 2 x 5.511.1847 PES brush Ø 457 mm-18"



- 2 x 5.511.1850 EWU pad driver Ø 457 mm-18"



- 6.508.0150 - Ø 457 mm - 18" - beige (5 pcs.)
- 6.508.00151 - Ø 457 mm - 18" - green (5 pcs.)
- 6.508.0142 - Ø 457 mm - 18" - black (5 pcs.)

Ride-on floor scrubber driers

A24 7100



Standard equipment



- 2 x 5.511.1097
PPL brush Ø 483 mm - 19"



- 4.508.0217
Front squeegee blade L.1270 mm
Shore 40 Th. 4 mm
- 4.508.0216
Rear squeegee blade L.1345 mm
Shore 33 Th. 6 mm



Watch the video on youtube:
www.youtube.com/fasavideo

A24 7100

- Suitable for maintenance and deep cleaning of medium and large areas (up to 6.000 m²)
- More than 90/120 kg of constant pressure on the brushes
- Large load tank capacity, resulting in reduced number of stops and maximum use of battery charge for effective operation of the machine
- Stability even when fully loaded
- Front independent wheel-drive with tight steering radius
- Easy access to electrical components
- Automatic brush plate lifting system
- Automatic squeegee lifting system
- Automatic squeegee lifting while reverse going
- Automatic control system for brush rotation and detergent water outflow
- Antifoam device
- Self-levelling brush plate
- Hour meter
- High-performance batteries resulting in high-working efficiency.

A24 7100

Code	8.578.0009
Power supply	36V DC
Equipped with	-
Scrubbing width	1020 mm
Squeegee width	1250 mm
Max working capacity	7140 m ² /h
Detergent tank capacity	200 l.
Recovery tank capacity	210-240 l.
Traction type	900W/front motorwheel
Brush/Vacuum motor power	1500W/600 W

Ride-on floor scrubber driers



The unique anti foam device dramatically reduces the foam generation and prevents it from touching the suction motor, thus protecting its operation. The electronic floating switch stops suction when the tank is full.

Large tank opening for fast and easy cleaning and sanitation.

The strong V-shaped floor squeegee made of steel profile is widely adjustable and allows to combine the operation of the rubber blades with the high suction power, to get a perfect drying result on every surface. The special filter box retains solid debris and prevents the obstruction of the suction hose.



A 24 scrubbers are easy to use thanks to the simple and user friendly controls. From the control panel the operator can adjust the maximum forward speed and the quantity of cleaning solution outflow, selecting the options most suitable to the dirt type. Job is simplified and made faster by the automatic lifting of the squeegee and of the brush plate.

Thanks to the optimal weight distribution and to the use of strong oil-proof polyurethane wheels the drive is perfect in all working conditions. The emptying of the solution water tank is quick with a simple and easy accessible mechanical tap.



Optional accessories:



- 0.107.0009 Battery box Pb-acid 36V 360Ah C5
- 0.107.0012 Gel battery box 36V 320Ah C5



- 0.108.0003 Battery Charger 24/36V 50/60A - 220-240/50-60



- 4.508.1167 Polyurethane front blade L.1270 TH. 4
- 4.508.0897 Polyurethane rear blade L.1345 TH. 6



- 2 x 5.511.1098 Tynex brush Ø 483 mm-19"
- 2 x 5.511.1128 PPL 0,03 brush Ø 483 mm-19"
- 2 x 5.511.1206 PES brush Ø 483 mm - 19"

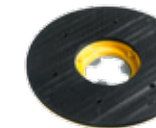

- 2 x 5.511.1099 EWU pad driver Ø 483 mm-19"



- 6.508.0034 - Ø 483 mm - 19" - beige (5 pcs.)
- 6.508.0041 - Ø 483 mm - 19" - green (5 pcs.)
- 6.508.0048 - Ø 483 mm - 19" - black (5 pcs.)

Ride-on floor scrubber driers

A35 8500



Standard equipment



- 3 x 5.511.1109
PPL brush Ø 406 mm - 16"



- 4.508.0219
Front squeegee blade L.1500 mm
Shore 40 Th. 4 mm
- 4.508.0218
Rear squeegee blade L.1580 mm
Shore 33 Th. 6 mm



Watch the video on youtube:
www.youtube.com/fasavideo

A35 8500

- Suitable for maintenance and deep cleaning of medium and large areas (up to 7.000 m²)
- More than 120-170 kg of constant pressure on the brushes
- 300 litres solution tank capacity allows exceptional autonomy and productivity
- Stability even when fully loaded
- Innovative traction system with three independent motor wheels controlled by electronic cards
- Easy access to electrical components
- Automatic brush plate lifting system
- Automatic squeegee lifting system
- Automatic squeegee lifting while reverse going
- Automatic control system for brush rotation and detergent water outflow
- Antifoam device
- Self-levelling brushes, hour meter, solenoid valve. High-performance batteries resulting in high-working efficiency

A35 8500

Code	8.572.0004
Power supply	36V DC
Equipped with	-
Scrubbing width	1220 mm
Squeegee width	1450 mm
Max working capacity	8540 m ² /h
Detergent tank capacity	280 l.
Recovery tank capacity	315-340 l.
Traction type	3 x 600W/3 wheels drive
Brush/Vacuum motor power	3 x 1000W/600 W

Ride-on floor scrubber driers



Designed to perform the hardest work and to resist even to extreme stresses with maximum comfort; the frame is made of steel profiles with a thickness varying from 5 to 12 mm, protected with a high resistance corrosion-proof paint. The unique anti foam device dramatically reduces

the foam generation and prevents it from touching the suction motor, thus protecting its operation. The electronic floating switch stops suction when the tank is full. Large tank opening for fast and easy cleaning and sanification. The cleaning solution tank with an exceptional capacity



of 300 liters and the high autonomy of the battery ensure a productivity at the top of the range. The wide rear opening allows for an easy and quick refilling of the cleaning solution tank. The motorwheels, designed and built by Fasa, grant optimal performances and exceptional reliability

(over 30.000 hours). The innovative 3wheel drive system ensures perfect traction in every operating condition. The high power of the three motorwheels allows the machine to get over remarkable slopes.



Optional accessories:



- 0.107.0010
Battery box Pb-acid
36V 525Ah C5
- 0.107.0013
Gel battery box
36V 400Ah C5



- 0.108.0003
Battery Charger 24/36V
50/60A - 220-240/50-60



- 4.508.1167 Polyurethane
front blade L.1270 TH. 4
- 4.508.0897 Polyurethane
rear blade L.1345 TH. 6



- 3 x 5.511.1110
Tynex brush Ø 406 mm-16"
- 3 x 5.511.1120
PPL 0,03 brush Ø 406 mm-16"
- 3 x 5.511.1204
PES brush Ø 406 mm - 16"



- 3 x 5.511.1111
EWU pad driver Ø 406 mm-16"



- 6.508.0031 - Ø 406 mm - 16" - beige (5 pcs.)
- 6.508.0038 - Ø 406 mm - 16" - green (5 pcs.)
- 6.508.0045 - Ø 406 mm - 16" - black (5 pcs.)



PROFESSIONAL LINE

Single disc machines

Impressive stability and working balance, operators could work for hours without any arm or body fatigue. Transmission with gearbox to ensure duration, power and noiseless; strong handle joint, ergonomic handle with all integrated safety switches with easy controls, protection traceless bumper, optional additional accessories for special applications available on request.

Single disc machines

ODM-R 45G

Complete range of single disc machines professional, sturdy, manageable, practical and simple to use. Adapted in order to satisfy all the cleaning requirements, marble restoration and treatment and natural stones, woods and parquet, moquette, dewaxing, hard scrubbing.

Optional:

Variety of brushes and pads for cleaning of different kinds of floors.



Accessories and brushes not included.



	ODM-R 45G 16-130	ODM-R 45G 16-160	ODM-R 45G 16-180	ODM-R 45G 40-160
Code	0.055.0312	0.055.0313	0.055.0314	0.055.0317
Type	low speed	low speed	low speed	medium speed
Brush speed	165 RPM	165 RPM	165 RPM	400 RPM
Scrubbing width	430 mm	430 mm	430 mm	430 mm
Voltage	230V/50HZ	230V/50HZ	230V/50HZ	230V/50HZ
Abs. power	1300 W	1600 W	1800 W	1600 W
Transmission	helical gear system			
Brush contact pressure	40,8 g/cm ²	41,3 g/cm ²	44,3 g/cm ²	34,9 g/cm ²
Noise level	60 dB(A)	60 dB(A)	60 dB(A)	60 dB(A)
Cable length	12 m	12 m	12 m	12 m
Body height	280 mm	280 mm	280 mm	280 mm
Dimensions/weight	54,2x42,5x120 cm/35 Kg	54,2x42,5x120 cm/41 Kg	54,2x42,5x120 cm/52 Kg	62,5x50,5x120 cm/45 Kg



Accessories for single disc machines

Description	Code	Models	Stripping synthetic floor (PVC)	Stripping cork present floor (linoleum)	Wet scrubbing/basic cleaning of stones, tiles and lino (sensitive floors)	Wet scrubbing/basic cleaning of synthetic or non sensitive floors pvc	Crystallizing	Carpet shampooing	Sanding wood	Sanding cement	Spray polishing and buffing
Brushes (*)											
 Carpet brush	0.955.0014	ODM-R 45G						x			
 Scrubbing brush PP 0,6 mm	0.955.0007	ODM-R 45G		x	x						
 Tynex brush	0.955.0004	ODM-R 45G	x			x					
Pad Holder											
 EWU pad holder	0.955.0016	ODM-R 45G	x	x	x	x	x			x	
 EWU pad holder	0.955.0017	ODM-R 45G 40-160									x
 Abrasive Disc Holder	0.955.0022	ODM-R 45G							x	x	
Special Disc											
 Carborandum disc	0.955.0027	ODM-R 45G								x	
Pads											
 Pad micro fiber 2 pcs	6.508.0116	ODM-R 45G						x			
 Pad beige 5 pcs	6.508.0032	ODM-R 45 G 40-160									x
 Pad green 5 pcs	6.508.0039	ODM-R 45G		x		x					
 Pad black 5 pcs	6.508.0046	ODM-R 45G	x								
 Pad silver Inox 5 pcs	6.508.0121	ODM-R 45G					x				
 Emery paper GR24 disc	0.955.0023	ODM-R 45G							x		
 Emery paper GR60 disc	0.955.0024	ODM-R 45G							x		
 Vidia disc GR24	0.955.0026	ODM-R 45G								x	
Vidia disc GR36	0.955.0025	ODM-R 45G								x	

X = suitable

(*): Brushed code 0.955.0014, 0.955.0007 and 0.955.0004 must not be used with medium speed model ODM-R 45G 40-160 (code 0.055.0317)

Accessories for single disc machines

Description	Code		Stripping synthetic floor (PVC)	Stripping cork present floor (linoleum)	Wet-scrubbing/basic cleaning of stones, tiles and lino (sensitive floors)	Wet-scrubbing/basic cleaning of synthetic or non-sensitive floors (PVC)	Crystallizing	Carpet shampooing	Sanding wood	Sanding cement	Spray polishing and buffing
11 l detergent tank 	0.955.0001K	SDM-R 45G 16-130	○	○	○	○		○			
		SDM-R 45G 16-160	○	○	○	○		○			
		SDM-R 45G 16-180	○	○	○	○		○			
Detergent 	3.697.0023	4 X 5 litres	•	•	•	•					
	3.697.0024	4 X 5 litres	•	•	•	•					
	3.697.0031	4 X 5 litres			•						
	3.697.0030	4 X 5 litres	•								
	3.697.0033	4 X 5 litres	•		•	•					
	3.697.0035	4 X 5 litres					•				
	3.697.0025	4 X 5 litres			•						•
	3.697.0026	4 X 5 litres				•					
	3.697.0027	4 X 5 litres									•

○ = optional • = available

Applications pads



MICROFIBER PAD - Ideal for "gres & porcelain" and carpet/moquette if used with dried foam shampoo.



BEIGE PAD - POLISHING - Polyester. To polish all kinds of floor. Use dry.



GREEN PAD - INTERMEDIATE CLEANING ACTION - Nylon. To remove all the old superficial wax, rests, obtaining ready floors to be recoated. Use wet.



BLACK PAD - WET STRIPPING - Nylon. For wet stripping of heavy layers of wax. Ideal to remove old floor finish scu and cement marks.



PROFESSIONAL LINE

Sweepers

FA-SA professional line, available both as electric and gas engine version, is made of sturdy shock-proof steel. Main controls are mechanically operated, to ensure maximum ruggedness and reliability in time. Top efficiency and work quality are granted by the back load, which allows a more complete dirt collection and consequent reduction of machine stops.

The brushes supplied are perfectly efficient on every kind of surface; tougher brushes are available on request, to meet more demanding cleaning requirements.

Easy routine maintenance: both main and side brush can be replaced by simply unscrewing three screws. FA-SA line is suitable for cleaning of medium-large surfaces, such as stores, squares, garages, deposits and parkings.

Walk-behind sweeper

TK 651 M



TK 651 M

- Ideal for small and medium surfaces • Easy handling
- Wide collector tank with safety lock • Side brush lifting
- Main brush pressure regulation • Separate side brush
- Adjustable working load on the brush
- Tilting handle • 360° front wheel • Die casting brush arm
- Traceless wheels • Shock proof frame • Hourly efficiency(max) 1500 m²/h.
- Working area (1 side brush) 500-700 mm.



TK 651 M

code	0.042.0102
main brush width	500mm
main brush + 1 side brush width	700mm
collector tank	40 lt
max working capacity	1500 m ² /h
brushes transmission	elastic belt
pressure on the brushes	regulable
dust-laying system	direct

Walk-behind sweeper

SW 2600 BT

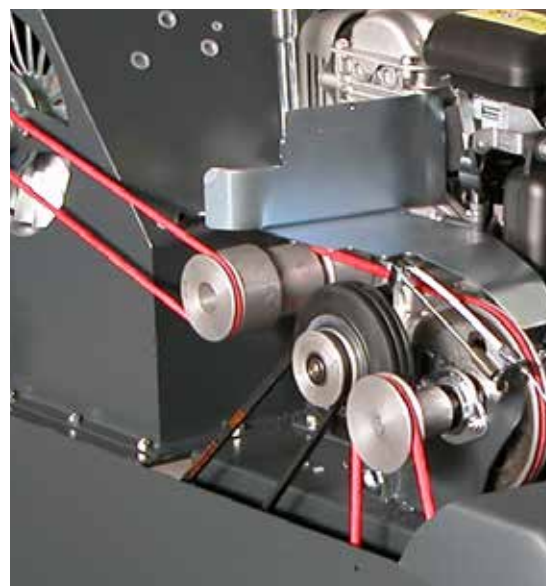

SW 2600

- Ideal for medium and large surfaces • Large filter surface with electric filter shaker (BT model)
- Manual filter shaker (SC model) • Side brush raising control • Suction switch off • Flap raise system
- Panel filter in horizontal position • Main brush pressure regulation • Indirect back collection
- Quick main brush release • Long life elastic belts • Reclining handle
- Suction selection lever • Traction lever • Antistatic device • Wide collector tank
- Heavy duty steel frame • Side brush mechanical engagement • Battery and battery charger not included.



Watch the video on youtube:
www.youtube.com/fasavideo

SW 2600 SC



	SW 2600 BT	SW 2600 SC
code	0.061.0010	0.061.0011
main brush width	510mm	510mm
main brush + 1 side brush width	680mm	680mm
collector tank	45 lt	45 lt
max working capacity	2620 m ² /h	2620 m ² /h
motor type/power	12V/400W	Honda 4 HP/2,9 kW
filtering surface	2 m ²	2 m ²
filter shaker	electric	manual

Walk-behind sweeper

SW 3700 SC



SW 3700 BT

SW 3700

- Ideal for medium and large surfaces
- Large filter surface with electric filter shaker (BT model)
- Manual filter shaker (SC model)
- Side brush raising control
- Suction switch off
- Flap raise system
- Panel filter in horizontal position
- Main brush pressure regulation
- Indirect back collection
- Quick main brush release
- Long life elastic belts
- Reclining handle
- Suction selection lever
- Traction lever
- Antistatic device
- Wide collector tank
- Heavy duty steel frame
- Side brush mechanical engagement
- Battery and battery charger not included.



Watch the video on youtube:
www.youtube.com/fasavideo



	SW 3700 BT	SW 3700 SC
code	0.061.0012	0.061.0013
main brush width	710mm	710mm
main brush + 1 side brush width	880mm	880mm
collector tank	60 lt	60 lt
max working capacity	3700 m ² /h	3700 m ² /h
motor type/power	12V/400W	Honda 4 HP/2,9 kW
filtering surface	3,02 m ²	3,02 m ²
filter shaker	electric	manual

Ride-on sweeper

SW R 4900 BT



SW R 4900 BT

- Ideal large surfaces
- Large filter surface distributed on 5 cartridge filters fitted with electric filter shaker
- Side brush raising control
- Suction switch off
- Flap raise system
- Flashing light
- Main brush pressure regulation
- Indirect back collection
- Front dust vacuum system
- Quick changing of the main brush and side brush without tools
- Long life elastic belts
- Suction selection lever
- Shock proof steel frame
- Traction lever
- Antistatic device
- Wide collector tank
- Heavy duty steel frame
- Perfectly balanced weight of the components, thus resulting in totally safe quick changes of direction
- Battery and battery charger not included.



SW R 4900 BT

code	0.061.0014
main brush width	650mm
main brush + 1 side brush width	850mm
collector tank	55 lt
max working capacity	4900 m ² /h
motor type/power	12V/1670W (5 motors)
filtering surface	4 m ²
filter shaker	electric

Ride-on sweeper

SW R 6200 BT SW R 8300 SC



SW R 6200 BT/SW R 8300 SC

- Ideal large surfaces • Large filter surface distributed on 6 cartridge filters fitted with electric filter shaker • Side brush raising control • **Complete right/left side brush** • Suction switch off • Lift flap pedal • Flashing light • Main brush pressure regulation
- Indirect back collection • Front dust vacuum system • Quick changing of the main brush and side brush without tools • Long life elastic belts • Suction selection lever • Shock proof steel frame • Traction lever • Antistatic device • Battery level indicator • Wide collector tank • Heavy duty steel frame • Adjustable seat • Perfectly balanced weight of the components, thus resulting in totally safe quick changes of direction • Battery and battery charger not included • Front light system (optional on request).



	SW R 6200 BT	SW R 8300 SC
code	0.061.0015	0.061.0016
main brush width	700mm	700mm
main brush + 1 side brush width	920mm c	920mm
collector tank	62 lt	62 lt
max working capacity	6200 m ² /h	8280 m ² /h
motor type/power	24V/1150W	Honda 5,5 HP/4,1 kW
filtering surface	6 m ²	6 m ²
filter shaker	electric	electric

SW R 6200 BT Lift SW R 8300 SC Lift



SW R 6200 BT Lift/SW R 8300 Lift

- Ideal large surfaces • Large filter surface distributed on 6 cartridge filters fitted with electric filter shaker • Side brush raising control • Unload device for tank emptying into dust containers up to 110 cm height
- **Complete right/left side brush** • Suction switch off. Lift flap pedal • Flashing light • Main brush pressure regulation
- Indirect back collection • Front dust vacuum system • Quick changing of the main brush and side brush without tools • Long life elastic belts • Suction selection lever • Shock proof steel frame
- Traction lever • Antistatic device • Battery level indicator • Wide collector tank • Heavy duty steel frame • Adjustable seat
- Perfectly balanced weight of the components, thus resulting in totally safe quick changes of direction • Battery and battery charger not included • Front light system (optional on request).



Watch the video on youtube:
www.youtube.com/fasavideo



	SW R 6200 BT Lift	SW R 8300 SC Lift
code	0.061.0017	0.061.0018
main brush width	700mm	700mm
main brush + 1 side brush width	920mm c	920mm
collector tank	62 lt	62 lt
max working capacity	6200 m ² /h	8280 m ² /h
motor type/power	24V/1150W	Honda 5,5 HP/4,1 kW
filtering surface	6 m ²	6 m ²
filter shaker	electric	electric

Ride-on sweeper

SW R 9700 BT SW R 9700 SC



SW R 9700 BT/SW R 9700 SC

- Ideal for large surfaces. • Large filter surface distributed on 8 cartridge filters fitted with electric filter shaker. • Side brush raising control. • On request DSA unload device for tank emptying into dust containers up to 145 cm height.
- **Complete right/left side brush.** • Anti-trace wheels (mod.BT). • Suction switch off. • Lift flap pedal. • Flashing light. • Main brush pressure regulation. • 90° steering angle. • Electric starter. • Service and parking brake. • Hour meter and klaxon. • Antislip platform. • Indirect back collection. • Front dust vacuum system. • Quick changing of the main brush and side brush without tools. • Long life elastic belts. • Suction selection lever. • Shock proof steel frame. • Traction lever. • Antistatic device. • Battery level indicator (mod.BT). • 115 lt wide collector tank. • Heavy duty steel frame. • Adjustable seat. • Battery and battery charger not included. • **Front working light system.**

	SW R 9700 BT	SW R 9700 SC
code	0.061.0037	0.061.0034
main brush width	800 mm	800 mm
main brush + 1 side brush width	1050 mm	1050 mm
collector tank	115 lt	115 lt
max working capacity	9700 m ² /h	9700 m ² /h
motor type/power	24V/1,91 kW	Diesel Yanmar/4,92 kW-6,7 Hp
filtering surface	6,4 m ²	6,4 m ²
filter shaker	electric	electric



Accessories for sweepers

			TK 651 M	SW 2600 BT	SW 2600 SC	SW 3700 BT	SW 3700 SC	SW R 4900 BT	SW R 6200 BT	SW R 8300 SC	SW R 6200 BT LIFT	SW R 8300 SC LIFT	SW R 9700 BT	SW R 9700 SC
	0.961.0001	Paper panel filter 14 micron		S	S									
	0.961.0002	Paper panel filter 14 micron				S	S							
	0.961.0016	Polyester panel filter 5 micron		O	O									
	0.961.0018	Hepa panel filter		O	O									
	0.961.0017	Polyester panel filter 5 micron				O	O							
	0.961.0019	Hepa panel filter				O	O							
	0.961.0003	Cartridge paper filter 14 micron						S					S	S
	0.961.0004	Cartridge paper filter 14 micron							S	S	S	S		
	0.961.0020	Cartridge polyester filter 20 micron						O					O	O
	0.961.0024	Cartridge polyester filter 20 micron							O	O	O	O		
	0.961.0025	Hepa cartridge filter							O	O	O	O		
	0.961.0180	Hepa cartridge filter						O					O	O
	0.942.0037	PP side brush	S											
	0.961.0005	PP side brush		S	S	S	S							
	0.961.0006	PP side brush						S						
	0.961.0007	PP side brush							S	O	S	O		
	0.961.0177	PP side brush											S	O
	0.961.0181	Mixed steel side brush		O	O	O	O							
	0.961.0023	Mixed steel side brush							O	S	O	S		
	0.961.0179	Mixed steel side brush											O	S
	0.942.0050	PP main brush	S											
	0.961.0008	PP - moplen body main brush - bristle Ø 0,5 mm		S	O									
	0.961.0009	PP - moplen body main brush - bristle Ø 0,5 mm				S	O							
	0.961.0010	PP - moplen body main brush - bristle Ø 0,5 mm						S						
	0.961.0011	PP - moplen body main brush - bristle Ø 0,5 mm							S	O	S	O		
	0.961.0176	PP - moplen body main brush - bristle Ø 0,5 mm												S
	0.961.0012	Mixed steel - moplen body main brush		O	S									
	0.961.0013	Mixed steel - moplen body main brush				O	S							
	0.961.0014	Mixed steel - moplen body main brush						O						
	0.961.0015	Mixed steel - moplen body main brush							O	S	O	S		
	0.961.0178	Mixed steel - moplen body main brush											O	S
	0.961.0021	Left side arm brush (with brush)						O						
	0.961.0022	Left side arm brush (with brush)							S	S	S	S		
	0.107.0002	Tubular battery Pb-acid - 12V 118Ah C5		O1	O1			O2						
	0.107.0063	GEL Battery 12 MFP 105 - 12V 105Ah C5		O1	O1			O2						
	0.107.0004	Tubular battery Pb-acid - 6V 180Ah C5		O2	O2				O4	O4				
	0.107.0023	Tubular battery Pb-acid - 6V 260Ah C5											O4	
	0.107.0072	GEL Battery 6 MFP 180 - 6V 180Ah C5		O2	O2				O4	O4				
	0.961.0026	Trolley for collector tank set (SWL 700)		O	O									
	0.961.0027	Trolley for collector tank set (SWL 900)				O	O							
	0.961.0029	Steel collector tank							O	O	O	O		
	0.961.0028	Side brush protection		O	O	O	O							
	0.961.0030	Side brush protection							O	O	O	O		

S = standard equipment O = optional

(1)-(2)= n° batteries

	0.108.0001	Battery charger type LWS 1-12/24V-12A	for battery 0.107.0002 - 0.107.0063	
	0.108.0002	Battery charger type LWS 2-12/24V-25A	for battery 0.107.0004 - 0.107.0072 - 0.107.0023	



PROFESSIONAL LINE

Steam generators

IVP is an electric generator producing saturated steam, at 10 atm pressure and 180°C temperature. IVP is suitable to degrease and sanitize any object or surface in an easy, ecological and definitive way, even in less reachable places, without any need of specific disinfecting products. This allows to reduce operating time to a minimum, thus resulting in a substantial decrease of labour costs as well as in energy saving and reduction of exhaust residuals to waste. It is ideal for food and baking industry, for private and institutional use, for pharmaceutical and mechanical industry, for dairy factories, for building sectors and so on.

Vacuum steam generators with suction



IVP 4.1 VAC

Standard equipment:

IVP 4.1 VAC

- Stainless steel body AISI 304
- Ready steam warning lamp
- Boiler 3kW S/S AISI 304 - Thickness 25/10
- Low level water lamp indicator
- Boiler is refilled continuously
- Switch for using chemicals and detergents mixed with steam
- Device for cleaning hot water mixed with steam
- Washable filter
- Flex hose 4 m
- Recovery tank capacity 64 l
- Drain hose system
- Steam regulation
- Wheels suitable for use in food processing area
- ON/OFF main switch with indicator lamp
- ON/OFF boiler switch with indicator lamp

IVP 4.1 Vac	
Code	8.451.0202
Absorbed power	3 Kw/230V-Ph1
Max pressure	7 bar
Steam production - max temperature	3,5 Kg/h - 158° C
Water tank/detergent tank	5/5 l.
Vacuum motor	1200 W
Depression	21 kPa/2100 mmH2O
Suction air	230 m3/h

• 5.211.0123



• 3.753.0141



• 3.754.0278



• 3.754.0005



• 3.754.0192



• 3.754.0109



• 3.754.0108



• 3.754.0110



• 6.405.0245



• 3.754.0194



• 3.754.0215



• 3.754.0196



• 3.754.0197



• 3.754.0204



• 3.754.0260



• 3.754.0271



• 5.212.0178



• 4.408.0454 - Sponge accessory

Vacuum steam generators with suction

New simple and intuitive control panel, quick-coupling steam gun, main ON/OFF switch with lamp, boiler ON/OFF switch with lamp, steam/detergent regulator/selector, steam flow rate regulator, steam ready warning lamp, low level water indicator lamp with buzzer, steam pressure gauge. Gun with integrated start-up control, adjustment of the vacuum power and steam function activation key.

Unlimited autonomy thanks to the continuous power supply of the boiler, which enables water top-ups in the tank without having to stop the machine or interrupt work.

Discharge pipe to quickly drain dirty water collected without removing the head. Bypass vacuum motor with cyclone effect. Equipped with 3 pumps: boiler, detergent and water.

Maximum safety thanks to the 2 safety thermostats, 1 pressure switch and 1 mechanical maximum pressure valve.



Watch the video on youtube:
www.youtube.com/fasavideo

Fields of applications

Steam system: Food & beverage (food industry, catering, beverage, winery).

Hospitality, community & healthcare (hospitality, buildings cleaning, spa & sport, education & community, healthcare).

Industry (industry, transportation, car washers, car dealers).

Vacuum steam generators with suction and foam system



IVP 4.1 VAC Foam

Standard equipment:

• 5.211.0123	
• 3.753.0141	
• 3.754.0278	
• 3.754.0005	
• 6.402.0106	
• 6.402.0113	
• 6.405.0245	
• 3.754.0194	
• 3.754.0215	
• 3.754.0196	
• 3.754.0197	
• 3.754.0204	
• 3.754.0260	
• 3.754.0271	
• 5.212.0178	
• 4.408.0454 - Sponge accessory	
• 3.697.0072 1l. LC prefoam	

IVP 4.1 VAC Foam

- Stainless steel body AISI 304
- Ready steam warning lamp
- Boiler 3kW S/S AISI 304 - Thickness 25/10
- Low level water lamp indicator
- Boiler is refilled continuously
- Switch for using chemicals and detergents mixed with steam
- Device for cleaning hot water mixed with steam
- Washable filter
- Flex hose 4 m
- Recovery tank capacity 64 l
- Drain hose system
- Steam regulation
- Wheels suitable for use in food processing area
- ON/OFF main switch with indicator lamp
- ON/OFF boiler switch with indicator lamp

IVP 4.1 Vac Foam

Code	8.451.0208
Absorbed power	3 Kw/230V-Ph1
Max pressure	7 bar
Steam production - max temperature	3,5 Kg/h - 158° C
Water tank/detergent tank	5/5 l.
Vacuum motor	1200 W
Depression	21 kPa/2100 mmH ₂ O
Suction air	230 m ³ /h

Vacuum steam generators with suction and foam system

New simple and intuitive control panel, quick-coupling steam gun, main ON/OFF switch with lamp, boiler ON/OFF switch with lamp, steam/detergent regulator/selector, steam flow rate regulator, steam ready warning lamp, low level water indicator lamp with buzzer, steam pressure gauge. Gun with integrated start-up control, adjustment of the vacuum power and steam function activation key.

Unlimited autonomy thanks to the continuous power supply of the boiler, which enables water top-ups in the tank without having to stop the machine or interrupt work.

Discharge pipe to quickly drain dirty water collected without removing the head. Bypass vacuum motor with cyclone effect. Equipped with 3 pumps: boiler, detergent and water.

Maximum safety thanks to the 2 safety thermostats, 1 pressure switch and 1 mechanical maximum pressure valve.



Fields of applications

Steam system:

Food & beverage (food industry, catering, beverage, winery).

Hospitality, community & healthcare (hospitality, buildings cleaning, spa & sport, education & community, healthcare).

Industry (industry, transportation, car washers, car dealers).

Foam system:

Car dealers, car washers, garages, car body shops, and every other place where a source of compressed air is already available















Watch the video on youtube:
www.youtube.com/fasavideo

Steam generators



GV Katla

Standard equipment:

• 5.409.0256	
• 3.753.0111	
• 3.754.0228	
• 3.754.0229	
• 3.754.0235	
• 3.754.0250	
• 3.754.0230	
• 6.405.0240	
• 6.402.0096	
• 3.754.0234	
• 6.402.0095	
• 3.099.0126	

Optional • 5.409.0254 Steam gun with hose (10 m)

GV Katla

- Saturated steam at 9 bar at a temperature of 175°C
- Steam gun with low tension control
- S. S. body AISI 304
- Boiler 3,3 kW S. S. AISI 304. Thickness 25/10
- Low level water lamp indicator
- Device for using chemicals and detergents mixed with steam
- Heating and activation time required: 7 min.
- Steam regulation
- Discharge valve
- Pressure gauge
- The boiler can be refilled from the tank provided (continuous duty)
- Wheels suitable for food and processing areas
- Storage basket.

GV Katla

Code	8.453.0001
Absorbed power	3,3 Kw/230 V-Ph1
Max pressure	9 bar
Steam production	4,62 Kg/h
Max temperature	175° C
Water tank capacity	5 l.
Detergent tank capacity	5 l.



Watch the video on youtube:
www.youtube.com/fasavideo

Steam generators

Simple and intuitive control panel, quick-coupling steam gun, main ON/OFF switch with lamp, boiler ON/OFF switch with lamp, water/detergent selector, steam flow rate regulator, steam ready indicator lamp, low water level indicator lamp with buzzer, steam pressure gauge. Steam gun with integrated steam/detergent function activation key and quick coupling of accessories. Unlimited autonomy thanks to the continuous power supply of the boiler, which enables water top-ups in the tank without having to stop the machine or interrupt work, with major time saving in the operating phase. Boiler with saturated steam at 9 bar at a temperature of 175°C.

Equipped with 3 pumps: boiler, detergent and water. Maximum safety thanks to the 1 safety thermostat, 1 pressure switch and 1 mechanical maximum pressure valve. Discharge valve for complete discharge of the boiler; it eliminates water residues and formation of lime scale, thus lengthening the lifespan of the boiler. A 5-litre water and detergent double tank. A rich and complete range of accessories is supplied. Fieldswater and scale growth, extending boiler's life.



Fields of applications

Steam system:

Food & beverage (food industry, catering, beverage, winery).

Hospitality, community & healthcare (hospitality, buildings cleaning, spa & sport, education & community, healthcare).

Industry (industry, transportation, car washers, car dealers).















Steam generators



IVP 3,3 M Gold

Standard equipment:

• 5.409.0256	
• 3.753.0111	
• 3.754.0228	
• 3.754.0229	
• 3.754.0235	
• 3.754.0250	
• 3.754.0230	
• 6.405.0240	
• 6.402.0096	
• 3.754.0234	
• 6.402.0095	
• 3.099.0126	

IVP 3.3 M Gold

• Saturated steam at 9 bar at 175°C temperature • Steam gun with low tension control • Made of AISI 304 stainless steel • Boiler 3,3 kW S/S AISI 304. Thickness 25/10 • Heating and activation time required: 7 min. • Steam regulation • Discharge valve • Pressure gauge • Device for using chemicals and detergents mixed with steam • The boiler can be refilled from the tank provided (continuous duty) • Pivoting wheels with brakes, suitable for use in food processing areas.

IVP 3,3 M Gold

Code	8.450.0027
Absorbed power	3,3 Kw/230 V-Ph 1
Max pressure	9 bar
Steam production	4,62 Kg/h
Max temperature	175° C
Water tank capacity	5 l.
Detergent tank capacity	5 l.

Optional • 5.409.0254 Steam gun with hose (10 m)



Watch the video on youtube:
www.youtube.com/fasavideo

Steam generators

Simple and intuitive control panel, quick-coupling steam gun, main ON/OFF switch with lamp, boiler resistance activation lamp, steam flow rate regulator, steam ready indicator lamp, steam pressure gauge. Steam gun with integrated steam/detergent function activation key and quick coupling of accessories. Boiler no water safety stop sensor. No water and water tank full lamp. Water pump activation lamp.

Detergent pump activation lamp. Water/detergent selector key. Boiler draining key. Unlimited autonomy thanks to the continuous power supply of the boiler, which enables water top-ups in the tank without having to stop the machine or interrupt work, with major time saving in the operating phase. Boiler with saturated steam at 9 bar at a temperature of 175°C.

Equipped with 2 pumps: boiler and detergent. Maximum safety thanks to the 1 safety thermostat, 1 pressure switch and 1 mechanical maximum pressure valve. Discharge valve for complete discharge of the boiler; it eliminates water residues and formation of lime scale, thus lengthening the lifespan of the boiler.

Equipped with 4 pivoting wheels suitable for food environments. A 5-litre water and detergent double tank. A rich and complete range of accessories is supplied.



Fields of applications

Steam system:

Steam system: Food & beverage (food industry, catering, beverage, winery).

Hospitality, community & healthcare (hospitality, buildings cleaning, spa & sport, education & community, healthcare).
Industry (industry, transportation, car washers, car dealers).

Steam generators



IVP 8 T Gold

NEW

IVP 8 T Gold

- Built-in AISI 304 stainless steel
- Pivoting wheels with brakes, suitable for use in food processing areas
- The boiler can be refilled from the tank provided (continuous duty)
- Discharge valve
- Pressure gauge
- Device for using chemicals and detergents mixed with steam
- Heating and activation time required: 6 min.
- Control with low tension controls
- Control panel: ON-OFF main switch, indicator lamp
- Saturated steam at 9 bar at a temperature of 175°C.

Standard equipment:

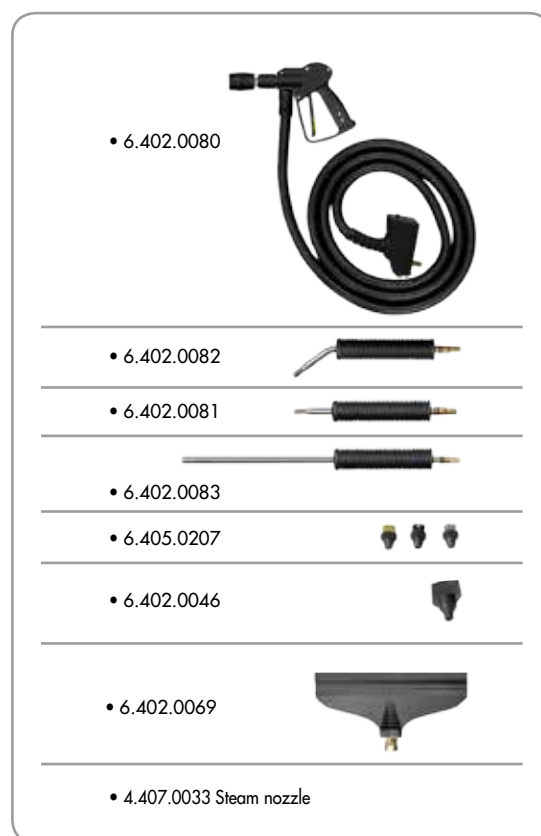

Optional:

- 6.402.0087 Steam gun with hose (6 m)
- 6.402.0085 Steam gun with hose (10 m)
- 6.402.0092 Straight lance mm 750 without nozzle
- 6.405.0197 Coupling for tanks Ø 80
- 6.402.0094 Extension 650 mm
- 6.402.0097 Lance with flat nozzle
- 6.402.0098 Brass bristles brush Ø 80
- 6.402.0112 Lance for barrel



Watch the video on youtube:
www.youtube.com/fasavideo

IVP 8 T Gold	
Code	8.458.0001
Absorbed power	8 Kw/400 V-Ph3
Max pressure	9 bar
Steam production	13,50 Kg/h
Max temperature	175° C
Water tank capacity	10 l.
Detergent tank capacity	5 l.

Steam generators

Simple and intuitive control panel, quick-coupling steam gun, main ON/OFF switch with lamp, boiler resistance activation lamp, steam flow rate regulator, steam ready indicator lamp, steam pressure gauge. Steam gun with integrated steam/detergent function activation key and quick coupling of accessories. Boiler no water safety stop sensor. No water and water tank full lamp. Water pump activation lamp.

Detergent pump activation lamp. Water/detergent selector key. Boiler draining key.

Unlimited autonomy thanks to the continuous power supply of the boiler, which enables water top-ups in the tank without having to stop the machine or interrupt work, with major time saving in the operating phase.

Boiler with saturated steam at 9 bar at a temperature of 175°C.

Equipped with 2 pumps: boiler and detergent.

Maximum safety thanks to the 1 safety thermostat, 1 pressure switch and 1 mechanical maximum pressure valve.

Discharge valve for complete discharge of the boiler; it eliminates water residues and formation of lime scale, thus lengthening the lifespan of the boiler.

Equipped with 4 pivoting wheels suitable for food environments. A 10l water and 5l detergent double tank.

A rich and complete range of accessories is supplied.



Fields of applications

Steam system:

Steam system: Food & beverage (food industry, catering, beverage, winery).

Hospitality, community & healthcare (hospitality, buildings cleaning, spa & sport, education & community, healthcare).

Industry (industry, transportation, car washers, car dealers).

Steam generators

IVP Vesuvio



IVP Vesuvio

- Built-in AISI 304 stainless steel
- Pivoting wheels with brakes, suitable for use in food processing areas
- The boiler can be refilled from the tank provided (continuous duty)
- Temperature regulator
- Discharge valve
- Pressure gauge
- Device for using chemicals and detergents mixed with steam
- Heating and activation time required: 6 min.
- Control with low tension controls
- Control panel: ON-OFF main switch, indicator lamp, thermoregulator, water and warning light (with buzzer), boiler activating key, gun activating key
- Saturated steam at 10 bar at a temperature of 180°C

Standard equipment:

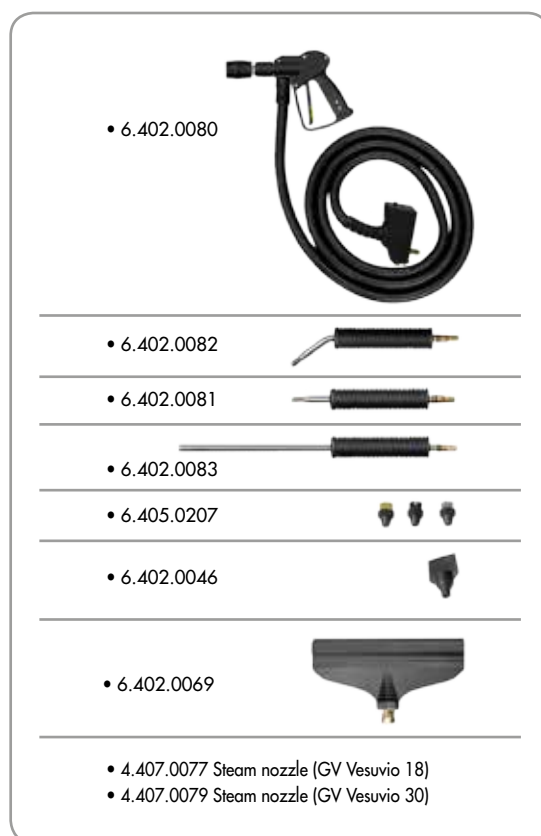

Optional:

- 6.402.0087 Steam gun with hose (6 m)
- 6.402.0085 Steam gun with hose (10 m)
- 6.402.0093 Steam gun with hose (15 m)
- 6.402.0090 Steam gun with hose (20 m)
- 6.402.0092 Straight lance mm 750 without nozzle
- 6.405.0197 Coupling for tanks Ø 80
- 6.402.0094 Extension 650 mm
- 6.402.0097 Lance with flat nozzle
- 6.402.0098 Brass bristles brush Ø 80
- 6.402.0112 Lance for barrel

	IVP 18 Vesuvio	IVP 30 Vesuvio
Code	8.452.0002	8.452.0001
Absorbed power	18 Kw/400 V-Ph3	30 Kw/400 V-Ph3
Max pressure	10 bar	10 bar
Steam production	22,5 Kg/h	37,5 Kg/h
Max temperature	180° C	180° C
Water tank capacity	25 l.	25 l.
Detergent tank capacity	5 l.	5 l.



Watch the video on youtube:
www.youtube.com/fasavideo

Steam generators

Simple and intuitive control panel, quick-coupling steam gun, main ON/OFF switch, activation lamp, electronic regulator of the temperature with digital display, low water level display with buzzer, boiler activation key, gun activation key, steam pressure gauge, steam selector and detergent selector. Steam gun with integrated steam/detergent function activation key and quick coupling of accessories.

Unlimited autonomy thanks to the continuous power supply of the boiler, which enables water top-ups in the tank without having to stop the machine or interrupt work, with major time saving in the operating phase. Boiler with saturated steam at 10 bar at a temperature of 180°C.

Equipped with 2 pumps: detergent and water. Maximum safety thanks to the 2 level controls, 1 thermostat, 1 pressure switch and 1 mechanical pressure valve. Discharge valve for complete discharge of the boiler; it eliminates water residues and formation of lime scale, thus lengthening the lifespan of the boiler. Double tank: 25 litres for water and 5 litres for detergent. Equipped with 2 pivoting wheels and appropriate brake to use in food environments + 2 fixed wheels. A rich and complete range of accessories is supplied with practical accessory holders.



Fields of applications

Steam system:

Steam system: Food & beverage (food industry, catering, beverage, winery).

Hospitality, community & healthcare (hospitality, buildings cleaning, spa & sport, education & community, healthcare).

Industry (industry, transportation).

Diesel steam generator



Metis

Standard equipment:



Optional:

- 6.402.0103 Steam gun with hose (15 m)
- 6.402.0104 Steam gun with hose (20 m)
- 6.402.0092 Lance mm 750 without nozzle
- 6.402.0081 Lance mm 175 without nozzle
- 6.402.0083 Lance mm 425 without nozzle
- 6.402.0046 Black plastic scraper l. 50
- 6.402.0069 Glass wiper
- 6.405.0197 Coupling for tanks Ø 40
- 6.402.0094 Extension 650 mm
- 6.402.0097 Lance with flat nozzle
- 6.402.0098 Brass bristles brush Ø 80
- 6.402.0112 Lance for barrel

Metis

- Vertical burner with high thermal efficiency steel coil
- Auxiliary motor for burner
- Discharge valve: allows a complete discharge of the boiler
- Temperatureregulator: the temperature is set-up by an electronic regulator
- Steam pressure gauge
- Low fuel indicator
- Double pipe gasoil pump
- User-friendly control panel
- Unit can be continually refilled
- Provided with 2 outputs for simultaneous work of two different operators.

Metis

Code	8.457.0001
Absorbed power	350 W/230 V-Ph1
Max pressure	10 bar
Steam production dry/wet	50/90 Kg/h
Max temperature	178° C
Burner type/fuel consumption	Diesel/2,83 l/h.
Water tank/fuel tank capacity	18 l./18 l.



Watch the video on youtube:
www.youtube.com/fasavideo

Diesel steam generator

Metis is a portable steam generator with a diesel fuel boiler. Unlimited autonomy thanks to no-stop water tank refilling. It does not leave any residues after cleaning. Metis water saving (over 90%) compared to normal high-pressure systems. Allows sanitisation tasks thanks to the combined use of steam and pressure. The operator does not require special protective overalls and protective masks. Provided with 2 outputs for simultaneous work of two different operators.

Portability: it does not need to be connected neither to the water supply because it is equipped with a water tank.

It is easy to move around, easy to use, and ready to use.

The advantages compared to normal high-pressure washing:

- Ecological: It consumes very little water (90% less than normal high-pressure cleaners) and does not require connection to the water supply.
- It does not require a collection tank to dispose of water reflux.
- Thanks to the high temperature that degreases and dissolves dirt, no polluting chemical products are required.
- Easy to use where required, it does not require connection to the water supply, the operator does not require special work clothing, excess water is not wasted.
- Ideal for maintenance cleaning and makes the bodywork of your car or motorbike shine without the risk of damaging it with the mechanical action of the high-pressure water.

Ideal for: Eliminating stubborn grease and dirt, leaving surfaces clean and shining. Cleaning is easy, all you need to do is use the cleaning and degreasing action of the steam at high temperature and collect residues with a microfibre cloth. Glass and delicate surfaces. Car interiors and for the most difficult parts to reach. Quick, thorough cleaning and sanitisation of mats without wetting them.



Diesel steam generator

NEW



Kolumbo 2way
With double guns
for two operators



Watch the video on youtube:
www.youtube.com/fasavideo

Kolumbo

Standard equipment:

- 6.402.0085
Hose 10 m
(Kolumbo 2way -
Two pieces)



- 6.402.0082
(Kolumbo 2way -
Two pieces)



- 6.405.0207
(Kolumbo 2way - Two pieces)



- 4.407.0079 Steam nozzle (Kolumbo/Kolumbo cordless)
- 4.407.0077 Steam nozzle (Kolumbo 2 way)

- **Columbo cordless** with batteries and battery charger

Optional:

- 6.402.0080 Steam gun with hose (3,5 m)
- 6.402.0087 Steam gun with hose (6 m)
- 6.402.0093 Steam gun with hose (15 m)
- 6.402.0090 Steam gun with hose (20 m)
- 6.402.0092 Lance mm 750 without nozzle
- 6.402.0081 Lance mm 175 without nozzle
- 6.402.0083 Lance mm 425 without nozzle
- 6.402.0046 Black plastic scraper l. 50
- 6.402.0069 Glass wiper
- 6.405.0197 Coupling for tanks Ø 40
- 6.402.0094 Extension 650 mm
- 6.402.0097 Lance with flat nozzle
- 6.402.0098 Brass bristles brush Ø 80
- 6.402.0112 Lance for barrel

Kolumbo

• Vertical burner with high thermal efficiency steel coil • Auxiliary motor for burner • Discharge valve: allows a complete discharge of the boiler • Temperature regulator: the temperature is set-up by an electronic regulator • Steam pressure gauge • Temperature regulator • Low fuel lamp • Integrated detergent tank with detergent delivery controller by the gun • Double pipe gasoil pump • User-friendly control panel • Unit can be continually refilled • Standard with double guns for 2 operators model Kolumbo 2Way code 8.628.0017 • Battery version: Kolumbo Cordless code 8.628.0025 (Battery charger 230 V-50 Hz).

	Kolumbo	Kolumbo cordless	Kolumbo 2 way
Code	8.628.0006	8.628.0025	8.628.0017
Absorbed power	350 W/230 V-Ph1	350 W/1x12V DC 75Ah C5	350 W/230 V-Ph1
Max pressure	10 bar	10 bar	10 bar
Steam production dry/wet	50/90 Kg/h	50/90 Kg/h	50/90 Kg/h
Max temperature	178° C	178° C	178° C
Burner type/fuel consumption	Diesel/2,83 l/h.	Diesel/2,83 l/h.	Diesel/2,83 l/h.
Water tank/fuel tank capacity	25 l./25 l.	25 l./25 l.	25 l./25 l.

Diesel steam generator

Kolumbo is a portable steam generator with a diesel fuel boiler. Unlimited autonomy thanks to no-stop water tank refilling. It does not leave any residues after cleaning. Major water saving (over 90%) compared to normal high-pressure systems. Allows sanitisation tasks thanks to the combined use of steam and detergents. The operator does not require special protective overalls and protective masks.

Portability: it does not need to be connected neither to the water supply because it is equipped with a water tank, nor to the electrical supply (cordless model) because it has a diesel fuel boiler. It is easy to move around, easy to use, and ready to use.

The advantages compared to normal high-pressure washing:

- Ecological: It consumes very little water (90% less than normal high-pressure cleaners) and does not require connection to the water supply.
- It does not require a collection tank to dispose of water reflux.
- Thanks to the high temperature that degreases and dissolves dirt, no polluting chemical products are required.
- Easy to use where required, it does not require connection to the water supply, the operator does not require special work clothing, excess water is not wasted.
- Ideal for maintenance cleaning and makes the bodywork of your car or motorbike shine without the risk of damaging it with the mechanical action of the high-pressure water.

Ideal for: Eliminating stubborn grease and dirt, leaving surfaces clean and shining. Cleaning is easy, all you need to do is use the cleaning and degreasing action of the steam at high temperature and collect residues with a microfibre cloth. Glass and delicate surfaces. Car interiors and for the most difficult parts to reach. Quick, thorough cleaning and sanitisation of mats without wetting them.



**NEW
CLEANING
SYSTEM**

2 in 1
Dry steam
+
high pressure
cleaner



Ultra Pressure Dry Steamer

UPDS Fuji

Standard equipment:



- 6.402.0102 - Steam gun with hose (10 m)



- 6.402.0082 - Steam lance



- 6.402.0110 - Steam/High pressure lance

- 4.407.0079 - Steam nozzle G 1/8 d = 3,75



- 3.103.0050 - High pressure nozzle 045

UPDS Fuji

Steam: Vertical burner with high thermal efficiency steel coil. Auxiliary motor for burner. Discharge valve: allows a complete discharge of the boiler. Temperature regulator: the temperature is set up by an electronic regulator. Steam pressure gauge. Temperature regulator. Low fuel lamp. Double pipe gasoil pump. User friendly control panel. Unit can be continually refilled. Safety solenoid valve. Device for cleaning hot water mixed with steam.

High pressure water: Three ceramic coated pistons brass linear pump head with built-in by-pass valve.

	UPDS Fuji
Code	8.455.0001
Operat. pressure	120 bar (150 bar max)
Delivery rate max	660 l/h
Max steam pressure/temperature	10 bar/178° C
Absorbed power	3000 + 350 W/230V ~ 50Hz (Ph 1)
Steam production dry/wet	50/90 kg/h
Burner type/fuel consumption	Diesel/2,83 l/h
Fuel tank capacity	18 l

Optional:

- 6.402.0103 Steam gun with hose (15 m)
- 6.402.0104 Steam gun with hose (20 m)
- 6.405.0207 Kit 3 brushes
- 6.402.0069 Glass wiper
- 6.402.0046 Black plastic scraper l. 50
- 6.402.0112 Lance for barrel



Watch the video on youtube:
www.youtube.com/fasavideo

Ultra Pressure Dry Steamer

Ultra Pressure Dry Steamer: a new revolutionary cleaning system.

The advantages of two cleaning systems are combined into one single product. An innovative cleaning system that combines the mechanical force of high-pressure water with the degreasing and disinfecting force of dry steam. Equipped with a 18 liters diesel tank, which makes the high pressure cleaning autonomous. A professional steam generator integrated with a cold water high-pressure cleaner, dual use for multiple applications in an all-in-one product.

With the cold water high pressure cleaner, which uses the mechanical force of the high pressure, you can quickly remove coarse and superficial dirt.

Thanks to the use of detergents is then possible to act effectively on all kinds of dirt and on all surfaces.

With the degreasing and sanitizing strength of dry steam it is possible to remove even the more aggressive dirt, allowing to clean car rims, the engine compartment, interior parts, floor mats.

Ideal for: Cleaning and sanitising car interiors, street furniture, playgrounds, removing chewing gum, degreasing mechanical parts in general, etc.

Fields of applications

Steam system:

Steam system: Food & beverage (food industry, catering, beverage, winery).

Hospitality, community & healthcare (hospitality, buildings cleaning, spa & sport, education & community, healthcare).

Industry (industry, transportation).



Device for dense foam production

NEW

FOAM box



FOAM box

Device for dense foam production and spreading. Easy to install, it requires only compressed air connection and power supply.

Ideal for cleaning: car body, car interiors, bathrooms, kitchens, slaughterhouses, food processing areas, health care settings, cellars.

Standard equipment:

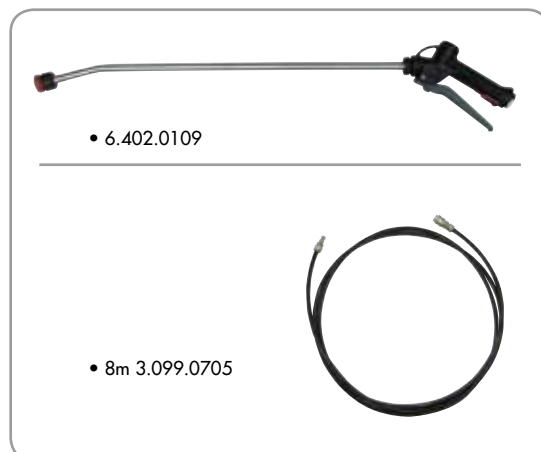

Optional:

- 3.697.0059 4x5 kg foaming cleanser for commercial vehicles
- 3.697.0057 4x5 Kg alkaline foaming cleanser for food industry
- 3.697.0058 4x5 Kg foaming cleanser for hygiene facilities
- 3.697.0056 4x5 kg foaming cleanser for cloth and carpets



Watch the video on youtube:
www.youtube.com/fasavideo



FOAM box

code	6.608.0074
voltage	220-240V ~ 50Hz
pumps no. - power	2 - 100W
air pressure	4 bar
delivery rate	1 l/m
detergent concentration	4%
dimension/weight	44 x 13 h 25/3 Kg

Chemicals & Sprayers

In order to complete the chemical products supply and to allow a better applicability and effectiveness, the sprayers are the perfect solution when supply wideness, use versatility and dosage saving are taken into consideration.

They are split into two different categories: pneumatic charge and continuous pneumatic charge.

Pneumatic charge sprayers need to be connected to an air compressor to charge the tank and allow the product vaporization without the connection to the air compressor. They work at high-pressures and so they use capacious steel or stainless steel tanks to allow a greater working autonomy.

Continuous pneumatic foam sprayers need a permanent connection to an air compressor; in this way air mixes with the chemical product producing a soft and voluminous foam that persists on surfaces: with a little chemical product, it is possible to treat wider areas or tough dirt (also on ceilings, inclined and/or slippery walls).

They work at high-pressure and so they use capacious steel or stainless steel tanks to allow a greater working autonomy.



FOAMJET SV24



SPRAY NV50



SPRAY NV24

The chemical product spraying is a finishing phase of cleaning task with other machines. The choice of the right product considering the kind of cleaning task grants the best result, complying with the environment and the machine that sprays the chemical product. Our chemical products range has been conceived complying with the strictest rules protecting the environment and avoiding the indiscriminating use of products damaging the environment. The right measuring and respect of the instructions we suggest are the best balance of the economical and technical needs of each up-to-date and aware cleaning task.

Code	Model	Product	Capacity	Recharging	Working pressure	Category	Single packaging weight	Single packaging weight	Single packaging dimensions	Pieces for pallet	Pallet dimensions
			liters		bar		kg	lbs	cm L x l x H	N°	cm L x l x H
0.006.0002	SPRAY NV24	Sprayer	24	Pneumatic	6	Trolley	17 kg	38	34x34x82	18	102x102x215
0.006.0003	SPRAY NV50	Sprayer	50	Pneumatic	6	Trolley	27 kg	60	47x47x107	12	141x107x205
0.006.0007	FOAMJET SV24	Foam sprayer	24	Air operating	6	Trolley	17 kg	38	34x34x82	18	102x102x215
0.006.0009	FOAMJET SX24 (Stainless Steel)	Foam sprayer	24	Air operating	6	Trolley	13 kg	29	34x34x82	18	102x102x215
0.006.0008	FOAMJET SV50	Foam sprayer	50	Air operating	6	Trolley	27 kg	60	47x47x107	12	141x107x205
0.006.0010	FOAMJET SX50 (Stainless Steel)	Foam sprayer	50	Air operating	6	Trolley	20 kg	44	47x47x107	12	141x107x205

Chemicals products



Code	Description	Quantity	High-pressure cleaners	Floor scrubber-driers	Steam generator	High-pressure cleaners	High-pressure cleaners
0.010.0030	Concentrated detergent CAR	12 pcs. x 2 l	X				
0.010.0029	Strong detergent SPRAYER	12 pcs. x 2 l	X				
0.010.0031	Cloth cleaner TEXIL	12 pcs. x 2 l					X
0.010.0032	Limescale remover DESCALER	12 pcs. x 2 l	X				
0.010.0033	Removes sea weeds and musk MUSCAL	12 pcs. x 2 l	X				
0.011.0001	Sand for sand blasters	6 pcs. x 5 Kg	X				
3.697.0023	Fragrance-free sanitising detergent LCN-800F	4 pcs. x 5 l	X	X		X	X
3.697.0024	Fragranced sanitising detergent LCN-800	4 pcs. x 5 l	X	X		X	X
3.697.0025	Alcoholic maintenance detergent LCN 680AL	4 pcs. x 5 l		X	X		X
3.697.0026	Non alcoholic maintenance detergent LCN-650	4 pcs. x 5 l		X			X
3.697.0027	Non stratifying wax wash detergent LCN-640 OWM	4 pcs. x 5 l		X			
3.697.0028	Pre-treatment detergent/acid maintenance LCA-125	4 pcs. x 5 l		X		X	
3.697.0029	Acid maintenance detergent LCA-125	4 pcs. x 5 l		X		X	
3.697.0030	Fragrance-free wax removing detergent LCB-900WR	4 pcs. x 5 l		X			
3.697.0031	Alcaline multi purpose detergent LCB-740F	4 pcs. x 5 l	X	X		X	
3.697.0032	Active chlorine degreasing detergent LCB-800CLF	4 pcs. x 5 l	X	X		X	
3.697.0034	Pickling and antioxidant detergent LCB-800DP	4 pcs. x 5 l				X	X
3.697.0035	Carpet and textile wash detergent LCN-700	4 pcs. x 5 l				X	X
3.697.0036	Foam inhibitor LC-PREFOAM	6 pcs. x 1 l		X			X
3.697.0044	Antiscale LC-PRECAL	4 pcs. x 5 l	X		X		
3.697.0037	Antiscale LC-PRECAL	6 pcs. x 1 l	X		X		

Chemicals products



CHEMICAL PRODUCTS FOR DENSE FOAM PRODUCTION

LC 104F



NEW

3.697.0059 4x5 kg



Foaming detergent for commercial vehicles

Monocomponent and alkaline detergent based on selected surfactants with a penetrating and softening action against both organic and inorganic dirt. It acts quickly and permanently, leaves no residue, is easy to rinse, does not alter painted parts made of plastic or rubber. Thanks to its high content of sequestrants, it maintains its detergent power even in the presence of hard water. Suitable for self-service high pressure washing plants, it can also be used in washing systems with nebulizer.

LC 102F



NEW

3.697.0057 4x5 kg



Alkaline foaming cleanser for food industry

Alkaline chloroactive fast-acting product, it cleans and sanitizes the surfaces and the equipment which are treated without leaving any residue. Used with a foaming nebulizer, it produces dense foam which sticks on the walls, enhancing its sanitizing action. Also suitable for floors, workbenches, equipment, etc..., it is used in dairy farms, slaughterhouses, salami factories, oil mills.

LC 103F



NEW

3.697.0058 4x5 kg



Foaming cleanser for hygiene facilities

Concentrated liquid detergent with acid pH. Ideal for cleansing stainless steel surfaces, it is used for cleaning and descaling all the acid-resistant surfaces. It effectively removes scale deposits, ferrous oxides and greasy surface dirt making the surfaces clean and without stains.

LC 101F



NEW

3.697.0056 4x5 kg



Foaming cleanser for cloth and carpets

Product indicated for cleaning car interiors made of fabric and of carpet. Formulated with special suspending additives that have the characteristic of breaking the physical-chemical bonds existing between fiber and dirt, attracting the latter to the surface. These substances also avoid the redeposit of dirt guaranteeing excellent cleaning results. Highly foaming, it has to be used with special extraction vacuum cleaners. It brightens the colors and leaves a pleasant perfume.

Dimension/weight

Model	Weight Kg	Package dimensions cm	N° pieces for pallet
Rap 110	6	30 x 27 h 45	48
Club 120	8,5	40 x 29 h 54	24
Indie 140	10,5	37 x 37 h 54	18
Celtic 20	14,5	30 x 30 h 57	24
Fusion 20	17	40 x 40 h 60	18
Rumba 150	10	30 x 31 h 27	36
Techno 160 S	11,2	57x38 h 30	24
Fusion 24	22	39 x 39 h 71	18
Progressive 28	27	40 x 42 h 105	12
King	27,3	58 x 38 h 58	12
Kappa A	43	63 x 43 h 73	8
Kaiman	69	85 x 65 h 100	1
Onega-R	28	43 x 50 h 56	12
Huron 5	28	39 x 39 h 61	18
Huron KA	29	39 x 39 h 61	18
Artic 1211	35	60 x 38 h 73	12
Caspian 1209	24	60 x 38 h 72	12
Tasman 1211	39	91 x 40 h 62	9
Tasman 1509	36	91 x 40 h 62	9
Tasman 1713	46	91 x 40 h 62	9
Tasman 2017	47	91 x 40 h 62	9
Tasman XL 2015	66	61 x 40 h 91	1
Tasman XL 2021	72	61 x 40 h 91	1
Tasman XL 2515	74	61 x 40 h 91	1
Explorer 2015	59	55 x 62 h 58	12
Explorer 2021	59	55 x 62 h 58	12
Clark 5H	38	55 x 55 h 70	8
Clark 11H	95	104 x 73 h 100	1
Clark 13H	95	104 x 73 h 100	1
Indian-R 1310	71	65 x 85 h 100	1
Desert 1509	94	69 x 85 h 111	1
Sundek5 1211	118	71x113 h 111	1
Sundek5 1511	118	71x113 h 111	1
Montigo 1211	104	69 x 85 h 111	1
Montigo 1611	104	69 x 85 h 111	1
Sundek5Y 1311	130	71 x 113 h 111	1
Sundek5Y 1515	143	71 x 113 h 111	1
Sundek5Y 2015	146	71 x 113 h 111	1
Maxima 2015	172	78 x 130 h 111	1
Maxima XXL 2021	183	78 x 130 h 111	1
Clark Hot 10	160	120 x 80 h 107	1
Clark Hot 17	240	120 x 80 h 107	1
WS 20	9,5	37 x 37 h 62	18
GTX 32E	10	37 x 37 h 81	18
Echo	7,4	39 x 39 h 42	30
Windy 120 IF	10	39 x 40 h 54	24
Windy 130 IF	11	39 x 40 h 79	15
Windy 265 PF	18,8	60 X 48 h 87	8
Windy 265 IF	19,8	60 X 48 h 87	8
Windy 365 IR	25,5	65 x 55 h 104	4
Windy 278 IF	29,6	75 x 60 h 103	4
Windy 378 IR	30,5	75 x 60 h 103	4
Windy IE Foam	26,5	65 x 55 h 104	4
Domino 53 inox	21,5	62 x 53 h 92	4

Model	Weight Kg	Package dimensions cm	N° pieces for pallet
Domino 78 inox	30,5	75 x 60 h 103	4
Domino 78 inox BS	33,5	75 x 60 h 103	4
Titano 78 PL-BS	32,5	75 x 60 h 103	4
Titano 78 inox BS	34,5	75 x 60 h 103	4
A1 36 E	62	81 x 56 h 80	1
A1 36 B	70	81 x 56 h 80	1
A3 45 E	123	113 x 61 h 110	1
A3 45 B	73	113 x 61 h 110	1
A4 45 E	88	117 x 58 h 78	1
A4 45 B	77	117 x 58 h 78	1
A4 45 B*	117*	117 x 58 h 78	1
A5 EVO 50 E	117	125 x 57 h 116	1
A5 EVO 50 BT*	140*	125 x 57 h 116	1
A5 EVO 50 T	85	125 x 57 h 116	1
A8 EVO 66 BTA	133	142 x 72 h 123	1
A9 50 BT	128	142 x 72 h 123	1
A9 55 T	131	142 x 72 h 123	1
A9 66 T	140	142 x 72 h 123	1
A12 75T	178	156 x 74 h 128	1
A12 Rider	175	140 x 82 h 135	1
A12 Rider*	251*	140 x 82 h 135	1
A13 R 75 Essential	226	152 x 97 h 154	1
A13 R 85 Essential	226	152 x 97 h 154	1
A13 R 75 UP	236	152 x 97 h 154	1
A13 R 85 UP	237	152 x 97 h 154	1
A18 R 90	320	200 x 118 h 171	1
A24 7100	381	200 x 118 h 171	1
A35 8500	670	230 x 135 h 190	1
ODM-R 45G 16-130	41	42 x 34 h 112	24
ODM-R 45G 16-160	42	54 x 42 h 120	16
ODM-R 45G 16-180	48	54 x 42 h 120	16
ODM-R 45G 40-160	46,5	54 x 42 h 120	16
TK 651 M	25	78 x 77 h 44	5
SW 2600 BT	78	126 x 63 h 85	1
SW 2600 SC	77	126 x 63 h 85	1
SW 3700 BT	89	126 x 83 h 85	1
SW 3700 SC	97	126 x 83 h 85	1
SW R 4900 BT	186	115 x 80 h 120	1
SW R 6200 BT	260	143 x 91 h 114	1
SW R 8300 SC	300	143 x 91 h 114	1
SW R 6200 BT LIFT	310	163 x 91 h 114	1
SW R 8300 SC LIFT	350	163 x 91 h 114	1
SW R 9700 BT	375	160 x 101 h 130	1
SW R 9700 SC	434	160 x 101 h 130	1
IVP 4.1 VAC	42,5	75 x 60 h103	4
IVP 4.1 VAC Foam	42,5	75 x 60 h103	4
GV Katla	31	75 x 60 h 70	10
IVP 3,3 M GOLD	37	59,5 x 44 h 65	2
IVP 8T Gold	40	59,5 x 44 h 65	2
IVP 18 Vesuvio	134	130 x 78 h 108	1
IVP 30 Vesuvio	134	130 x 78 h 108	1
Metis	110	113 x 71 h 111	1
Kolumbo	140	130 x 78 h 108	1
UPDS Fuji	130	113 x 71 h 111	1

* = weight of packed machine, without batteries

GENERAL TERMS OF SALE

Goods travel at buyer's risk. Images and technical specifications of products and accessories are not binding and can be modified without notice.

